

mistral[®]

203cm Matte Black Aluminium Ceiling Fan with Remote



Instruction Manual

Model: MBF851



Important Safeguards

When using electrical appliances, in order to reduce the risk of fire, electric shock and/or injury, these basic safety precautions should always be followed:

For Your Safety

Read all instructions carefully, even if you are quite familiar with the appliance.

- This appliance is not intended for use by young children or infirm persons unless they have been adequately supervised by a responsible person to ensure that they can use the appliance safely.
- Young children should be supervised to ensure that they do not play with the appliance.
- Choose a location for the fan which will ensure adequate clearance from all objects and walls and with blade height greater than 2.1 metres from the floor.
- Suitable for Indoor and covered /sheltered outdoor areas where fan will not be exposed to weather conditions.
- To ensure a satisfactory installation read the provided installation instructions thoroughly.
- All Electrical work must only be conducted by an licensed Electrician in accordance with National , state or local electrical regulation / codes. On completion have installer provide you with Certificate of Electrical installation compliance, to be retained for warranty purpose when requesting service.
- To avoid possible shock, be sure electricity is turned off at the fuse box before wiring, and do not operate fan without blades.
- At the chosen mounting position,check to confirm if there is a ceiling joists to which the fan can be secured. If there is no suitable supporting member, than a mounting brace must be fitted between ceiling joists to provide a secure mounting point that is capable of supporting a minimum of 44 Kg.
- The fan must be earthed.
- The fixing means for attachment to the ceiling such as hooks or other devices shall be fixed with a sufficient strength to withstand 4 times the weight of the ceiling fan.

- Do not connect the fan motor to a dimmer switch. This may give an unsatisfactory performance (motor hum) and cause damage to the motor.
- It is not recommended that ceiling fans and gas appliances be operated in the same room at the same time.
- Do not insert anything into the fan blades while the fan is operating. This will damage the blades and upset the balance of the unit causing the unit to wobble.
- After completion of the installation , check to ensure that all connections and mounts are securely tightened to prevent these from coming loose during fan operation.
- The ceiling fan is suitable for use in home, or similar ceiling of swimming pool , workshop, or farm house etc.
- Because of the fan's natural movement, some connections may loosen. Check the support connections, brackets and blade attachments twice a year to make sure they are all secured. If they are loose, tighten with a screwdriver.
- Be careful of the fan and blades when cleaning, painting, or working near the fan. Always turn off the power to the ceiling fan before servicing.

WARNING: TO REDUCE THE RISK OF ELECTRIC SHOCK, IN ACCORDANCE WITH NATIONAL, STATE AND LOCAL APPLICABLE ELECTRICAL REGULATIONS /CODES , FAILURE TO DO SO MAY VOID YOUR WARRANTY.

WARNING: This product is designed to use only those parts supplied with this product and/or accessories designated specifically for use with this product. Using parts and/or accessories not designated for use with this product could result in personal injury or property damage.

WARNING: To reduce the risk of personal injury, do not bend the blade bracket (flange or blade holder) when installing.

WARNING: Only mount in location that is suitable to support the weight of the fan, both stationary ,during operation , when balancing fan blades or cleaning the fan. Do not insert foreign objects in between rotating fan blades.

Note: The important safeguards and instructions given in this manual are not meant to cover all possible conditions and situations that may occur. It must be understood that common sense, caution and care are factors, which cannot be built into any product. The persons caring for and using the unit must supply these factors.

Consult only a licensed electrical contractor for installation. In the unlikely event of damaged or missing parts, refer to the In Home Warranty contact details listed on the Warranty card or the original place of purchase.

That the mounting of the suspension system shall be performed by the manufacturer, its service agent or suitably qualified persons.

Warning

If unusual oscillating movement is observed, immediately stop using the ceiling fan and contact the manufacturer, its service agent or suitably qualified persons.

This product has not been designed for any uses other than those specified in this booklet.

Save These Instructions

Energy Efficient Use of Ceiling Fans

Ceiling fan performance and energy efficiency rely heavily on the proper installation and use of the ceiling fan. Here are a few tips to ensure efficient product performance.

Turn the fan Off in areas where fans are used are not occupied. Ceiling fans do cool the occupants, not the room. Using the Ceiling Fan Year Round Summer Season: Use the ceiling fan in the counterclockwise direction. The airflow produced by the ceiling fan creates a wind-chill effect, making you "feel" cooler. Select a fan speed that provides a comfortable breeze, lower speeds consume less energy.

Winter Season: Reverse the motor and operate the ceiling fan at low speed in the clockwise direction. This produces a gentle updraft, which forces warm air near the ceiling down into the occupied space. Remember to adjust your Heating or AC thermostat when used in conjunction with the ceiling fan.

This manual is prepared to make it as easy as possible for you to assemble, install, operate and maintain your ceiling fan

Getting Ready

Warning: The ceiling fan must be installed only by a licensed electrician.

Warning:
Do not install or use fan if any part is damaged or missing. This product is designed to use only those parts supplied with this product and/or any accessories designated specifically for use with this product. Substitution of parts or accessories not designated for use with this product could result in personal injury or property damage.

Preparing for Installation

Before you begin installation, refer to the instructions.

Proper ceiling fan location and attachment to building structure are essential for Safety and reliable operation.

Checking Your Fan Parts

Carefully unpack your fan to avoid damage to the fan parts. Refer to the included Parts instruction Check for any shipping damage to the motor or fan blades. If any parts are missing or damaged, contact Consumer Service Support phone number.

Important Notes

Fan Installation

Under our warranty terms, this ceiling fan must be electrically installed by a licensed electrician. Improperly installed ceiling fans can be dangerous and expensive to repair. Warranty is void if not installed by a licensed electrical contractor. This fan is designed for Indoor and covered/weather protected outdoor areas, mounting where the fan is subject to water or moisture is dangerous. Any change to external finish is not covered by warranty.

It needs to be installed by a licensed electrician.

Note: MECHANICAL NOISE MAY BE NOTICED ON INSTALLATION-ALLOW AT LEAST 8 HOURS SETTLING-IN PERIOD. SOME FANS MAY WOBBLE MORE THAN ANOTHER - EVEN IN THE SAME MODEL, IT DOES NOT NECESSARILY INDICATE THE FAN IS FAULTY.

Note: The replacement of parts of the safety suspension system device shall be performed by the manufacturer, its service agent or suitably qualified persons.

Features of Your Ceiling Fan with Remote Control

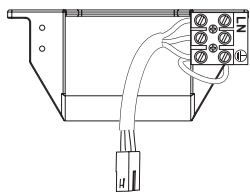
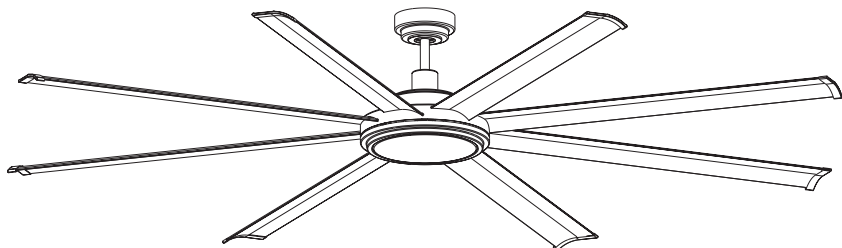

Mounting Bracket

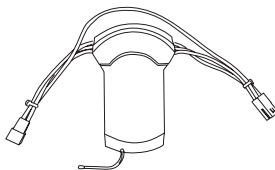

Receiver

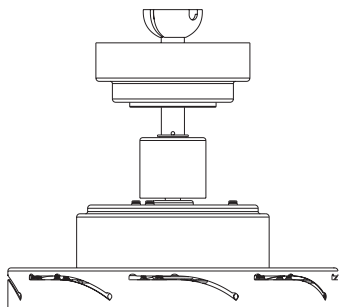

Fan Motor Assembly



Blade X8

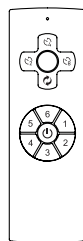

Remote Control

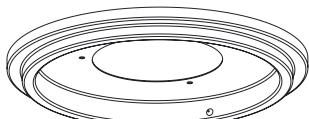

METAL PLATE



METAL SHADE



12" Downrod

Getting to Know Your Ceiling Fan with Remote Control

Congratulations on the purchase of your new Ceiling Fan.

Before first using your new Ceiling Fan, it is most important that you read and follow the instructions in this use and care booklet, even if you feel you are familiar with this type of appliance.

Your attention is drawn particularly to the section dealing with IMPORTANT SAFEGUARDS. Find a safe and convenient place to keep this booklet handy for future reference.

This Ceiling Fan has been designed to operate intended for Domestic use.

Your Ceiling Fan is safe and easy to use. It has been designed to function quietly and safely under normal circumstances. Your Ceiling Fan is contemporary design. Its energy efficient blades circulate cool air while using less power than a standard light globe. The heavy-duty motor is rated for continuous use to combat long hot summers.

The diameter of fully assembled ceiling fan is approximately 203 cm and can be attached with 2 different length down rods in accordance with the ceiling height and to ensure that minimum height of 2.1 metres from floor is maintained.

The ceiling fan is operated via remote control, there is no need to install wall controller.

Assembly the downrod of your ceiling fan

The ceiling fan has been pre-assembled with the short (15cm) downrod. If required you can change to fit the 30 cm downrod provided, follow below steps to assembly. (Fig.1 & 1a)

1. Remove the hanging ball portion from the downrod on motor assembly by loose the set screw in the hanger ball until the ball slides freely down the downrod.
2. Remove the pin from the downrod, then remove the hanging ball, ceiling canopy, ceiling canopy support ring, and fan motor cowl.
3. Remove the hairpin clip and clevis pin from bolt screws in the bottom of the downrod.
4. Loosen the screw nut and flat washers, spring washers from the the bolt screws.
5. Pull out the two bolts screws from the downrod and downrod from motor coupling, at the same time pull out the supply wire from the downrod. Retain the hanging ball, pin and clip and screw sets and motor coupling cover for reinstallation.

WARNING: Do not damage the supply wire while it be pull or pass through the downrod.

6. Change over to the 30 cm downrod and re-assemble in reverse order.

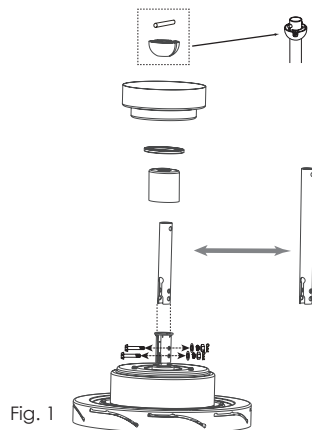

Fig. 1

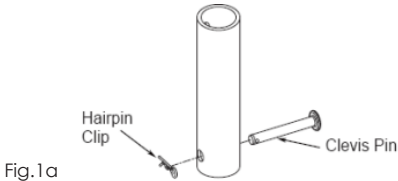
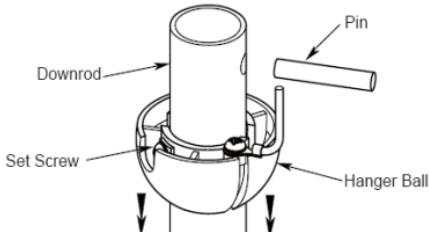

Fig.1a

Warning:

It is critical that the clevis pin in the downrod support is properly installed and the set screws and nuts are securely tightened. Failure to do so could result in the fan dislodging from the mount and falling down..

NOTE: All set screws must be checked, and retightened where necessary, before installation

Installing the Ceiling mounting bracket

Securely attach the ceiling mounting bracket to the ceiling near a supply wire and using the mounting bracket screws and washers supplied with the ceiling fan.

1. Choose a location for the fan which will ensure adequate clearance from all objects and walls and with blade height greater than 2.1 metres from the floor.

Mounting bracket assembly

2. At the selected mounting position, check whether there is a ceiling joist to which the fan can be secured. If there is no suitable support member, install a 45x90mm brace between ceiling joists. Use the hanging bracket as a template to mark the screw holes positions and the center of the bracket. Drill 25mm Dia. hole at the center mark through both plaster and timber brace/Joist for power supply cable to be fed through. Drill 2 x 3.0mm pilot holes for the bracket mounting screws. Attached the bracket and secure with the 5.0 mm x 38mm screws, washers and leveling pads provided. (Fig.2)

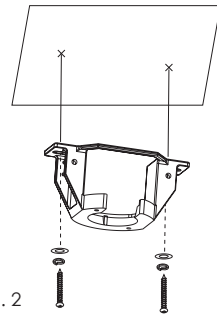

Fig. 2

NOTE: Ensure the mains power supplies are switched OFF during installation. The bracket screws (5x38mm 2pcs) provided is for use with wooden structure only. For structures, other than wood, the appropriate screw type MUST be used.

The ceiling support member to which the fan assembly is attached must be able to support 44 Kg.

IMPORTANT NOTES:

Means of disconnection must be incorporated in the fixed wiring in accordance with the wiring rules.

The Electrical terminations must only be carried out by a Licensed Electrician that can issue an installation compliance certificate on completion.

3. Connect the supply wiring Active, Neutral and Earth into the terminal block on mounting bracket.(Fig.3)

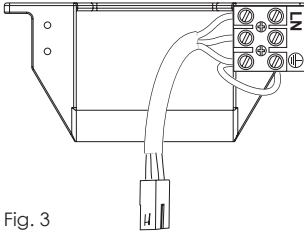

Fig. 3

WARNING: Ensure the mains power supplies are switched OFF during installation.

NOTE: Once ceiling fan assembly is hoisted in position onto the hanging bracket with the conductors and safety cable fed through 25mm clearance hole, the safety cable must be secured to adjoining joist with 3/8" x 2" bolt , washer and nut.

Note: Make sure that electrical conductors , hanging bracket earth conductor and safety cable are all fed through the downrod before positioning the fan assembly into the hanging bracket , so licensed electrician can complete the termination to power supply.

Assembly of Your Ceiling Fan

For ease of assembling the fan blades to the ceiling fan motor housing, turn entire motor housing upside down , allow for clearance of the protruding downrod.

Ensure to position/protect it so it does not scratch/damage motor housing during blade installation process.

Remove the 3 screws of the fan blade mounts (Do one fan blade installation at the time).

Install the first fan blade and repeat process for all fan blades until completed.

Position the fan blade with the 3 pre-drilled holes facing the motor housing and align with the holes on the motor housing of the screws previously removed.

Secure fan blade with the three screws and tighten. (Fig.4/5)

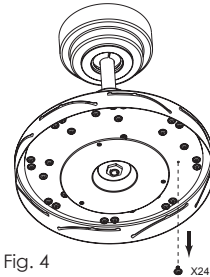

Fig. 4

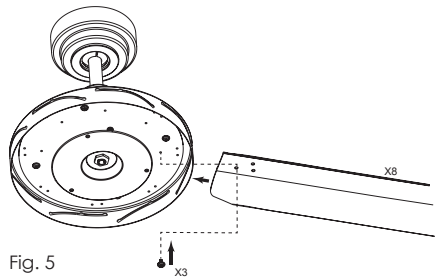

Fig. 5

On completion of fitting the 8 blades , fit metal plate with 3 screws and push motor shade to fit into motor plate by align the groove then turning anti-clockwise to secure in position. (Fig.6/7).

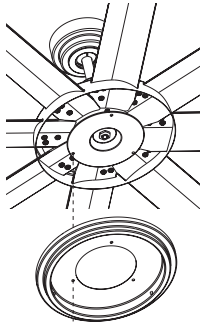

Fig. 6 x3

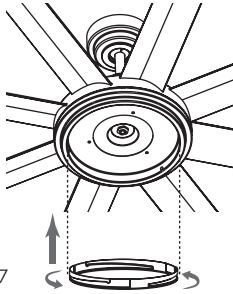

Fig. 7

Turn the ceiling fan assembly over in preparation for installation onto hanging bracket.

Hanging The Ceiling Fan And Electrical Connection

Before hoisting the ceiling fan assembly in position , the fan motor cowl, ceiling canopy support ring , ceiling canopy must be placed over the down rod assembly.

Hoist the fan assembly into position, ensuring that the groove in the ball joint aligns with positioning tabs on the hanging bracket. (Fig.8,9,10)

Fig. 8

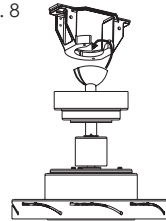

Fig. 9

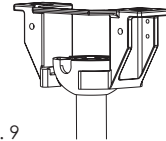
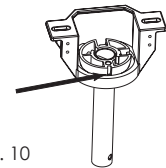

Fig. 10



Note: Before hanging the ceiling fan, you should put the ceiling canopy, canopy support and motor Cowl over the downrod.

Note: The fan is heavy, it need two persons to help lift and hanging.

If your ceiling is vaulted or angled ceiling. Should refer below Angle Mounting recommended for a vaulted or angled ceiling instruction to installation:

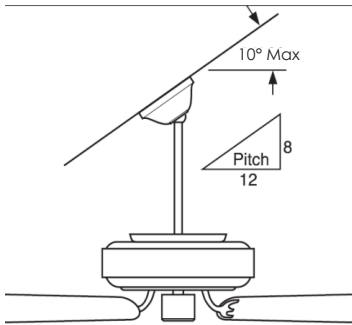

Slide the remote control receiver module above the downrod inside the hanging bracket and firmly push into place. (Fig.11)

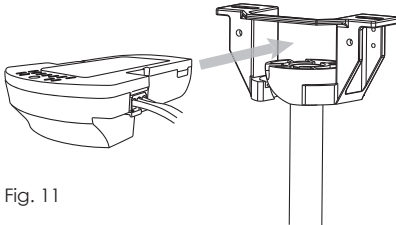

Fig. 11

Make the connection of both plugs extending from the receiver module to the corresponding connector sockets on the hanging bracket and connector socket protruding through the downrod extending from the motor housing and well arrange the connection wire without damage. (Fig.12)

Note: The plugs extending from the remote receiver module have a designated Input and Output , so ensure that these correctly connected to corresponding sockets.

IMPORTANT NOTES:

Means of power supply isolator must be incorporated in the fix wiring, in accordance with the wiring rules. Incorrect conductor termination will damage the unit.

If this fan is a replacement for an existing fan, remove the existing wall speed controller.

Warning: Make sure the mains power is turned OFF during this time and ensure that the connection is secure.

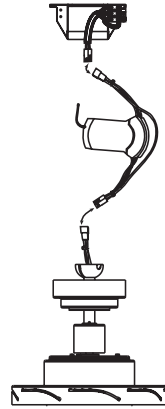

Fig.12

Warning : All electrical connections for installation of this ceiling fan must only be carried out by an Licensed Electrician. Power supply must be isolated during the electrical installation process.

Ceiling canopy install

The hanging bracket has 2 canopy retaining screws pre-fitted, remove only 1 of these two screws and loosen the second screw by a few turns only.

Slide the ceiling canopy upwards, the canopy has a keyhole slot on one side, align this keyhole slot with the loosened screw still retained on the bracket and turn canopy anti-clockwise to capture it.

Align other screw hole in canopy with the second screw hole (from which screw was fully removed) on the mounting bracket and secure canopy with second screw.

Fully tighten the two canopy retaining screws.

Slide the canopy support flange upwards, the holes in the flange are keyhole slotted, align with the screws protruding from the canopy , position flange and turn anti-clockwise to secure. (Fig.13)

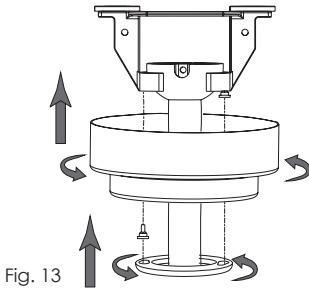

Fig. 13

The ceiling fan installation process is now completed.

Note: On completion of installation the distance from floor to lowest point of fan blades must not be less than 2.1 Meter. (Fig.14)

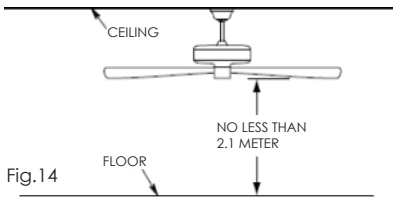

Fig.14

Check all the internal wiring and assembly of the fan before operation.

Operation of Ceiling Fan with Remote Control

Note: The operation of the Ceiling fan is fully controlled via the remote control.

Prepare remote control for operation and installation of wall mount remote holder.

After confirmation from Licensed electrician that power supply to ceiling fan has been activated, the electrician should check correct operation of the fan.

Loosen the screw in the battery compartment cover and then remove the battery compartment cover of the remote control and install the 12V (Battery Type: 23A 12V) supplied with the unit, Re-fix the cover and tighten the screw after the battery was installed.

Allow Electrician to test and confirm safe operation.(Fig.15)

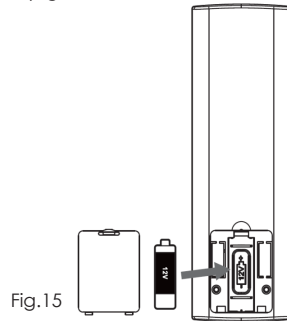

Fig.15

WARNING: Battery should insert correctly. Do not recharge, do not dispose of in a fire or oven, may explode, leak or cause damage. Where possible dispose of your used batteries through your local council and other battery recycling centres. Keep batteries away from children.

Installing the Remote Control Holder

Determine a suitable spot for installing the remote control holder in the vicinity of the installed fan.

Locate the nearest wall stud , mark hole position by using holder as template , drill pilot holes smaller than diameter of the screw and secure holder to the wall with the screws. (Fig.16)

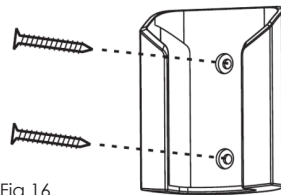



Fig.16

Remote Reset

Turn on your main power source of the ceiling fan.

NOTE: If the remote control is not operating the fan, it may need a reset and procedure for the reset is detailed below:

After turn the ceiling fan Mains Power on, do not press any other button on the remote control before pressing  the button. Doing so will cause the procedure to fail. Should you need to use another remote control with your new ceiling fan, the same steps below apply:

Step 1. Turn the main power source off to begin the reset process.

Step 2. Turn mains power back On .

Step 3. Within 30 seconds of turn on the ceiling fan, press and hold the  button for 5 seconds to enter the reset process and wait a moment, the reset process is finished.

Operating the Ceiling Fan

The Ceiling fan has 6 dedicated speed settings ,these can be selected by pressing the number buttons (1-6) surrounding the Power On/Off Button.

- 1 = Low speed,
- 2 = Medium Low speed
- 3 = Medium speed
- 4 = Medium High speed
- 5 = High speed
- 6 = Extra High speed

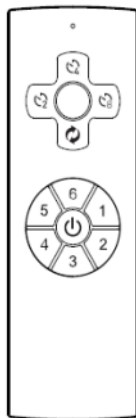





Fig.17

On/Off button()

Operating the ceiling fan direct press any of the dedicated speed buttons (1-6) to select your desired speed setting and Press () button to turn fan Off.

Timer button (, ,)

The ceiling fan has built a timer function. Turn on the ceiling fan and it is in normal operation, press the timer setting , ,  button, The ceiling fan will automatically turn off after operation for 2, 4 or 8 hours.

Fan reverse button () button:

The ceiling fan has reverse rotate function, To operate the reverse rotate function on this ceiling fan, press the reverse  button while the fan is running or is stop.

Note: While the ceiling fan is in running and operate to reverse function, the ceiling fan will slow down to stop and then to reverse rotation.

Note: Speed settings for warm or cool weather depend on factors such as the room size. Ceiling height, Number of fans and so on.

Warm weather - (Forward) A downward airflow creates a cooling effect as shown in (Fig.18)

This allows you to set your air conditioner on a warmer setting without affecting your comfort.

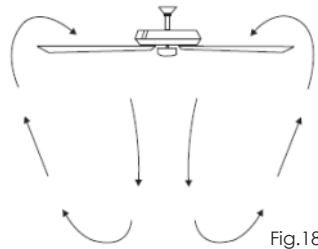

Cool weather - (Reverse) An upward airflow moves warm air off the ceiling area as shown in (Fig.19) This allows you to set your heating unit on a cooler setting without affecting your comfort.

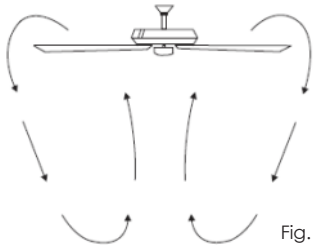

Turn off the ceiling fan and switch off the power mains power supply while not in use or Unattended.

NOTE: If the ceiling fan motor overheats due to long periods of use at high speed the ceiling fan will auto Power-Off and can be turned back on when cooled down.

Care & Cleaning

Periodic cleaning of your ceiling fan is the only maintenance required. Use a soft brush or lint free cloth to avoid scratching the finish. Please turn off electricity when you do so.

- Do not use water when cleaning your ceiling fan. It could damage the motor or the wood blades and create the possibility of an electrical shock.
- Motor has permanently lubricated ball bearing. No need to oil.

Specification:

Power Supply: 240V~ 50Hz

Power consumption: 35W

Motor type: DC motor with Reversible

Weight: 11kgs

Speed: 6 speed

Note: As a result of continual improvements, the design and specifications of the product within may differ slightly to the unit illustrated on the packaging.

Trouble - Shooting Checklist

Trouble	Probable Cause	Suggested remedy
1.Fan Will not Start	A: Fuse or circuit breaker blown B:Loose line wire connections to the fan C:Speed controller not in correct position	A/ Check main and branch circuit fuses or circuit breakers. B/ Check line wire connections to fan C/ Check speed controller's position
2.Fan Wobbles	A:Fan blades are not horizontal to ceiling. B: Blade screws are loose	A/ Measure from ceiling to tip of blades, then rotate fan so all blades are checked for equal height from ceiling (adjustments may be made by slight pressure up or down on blade holders). B/ Make sure all screws are securely fastened.
3.Fan Sound Noisy	A: Top canopy touching ceiling. B:Loose fan blade screws C: Ceiling fan not secured against ceiling. D: Incorrect speed controller	A/ Lower Canopy from ceiling to ensure minimum 3 mm clearance. B/ Re-tighten all screws on fan blades but never over-tighten. C/ Re-tighten all screws in the hanging bracket or plate. D/ Change the controller to the one supplied
4. Mechanical Noise	A: Allow at least 8 hours for setting in period	

Disposal

Respect the environment, dispose of Batteries in accordance with local requirements.

Warranty Conditions for purchase in Australia & New Zealand

Any claim under this warranty must be made within 2 years of the date of purchase of the product. To make a claim under the warranty in Australia, take the product (with proof of purchase) to any Bunnings store (see www.bunnings.com.au in Australia or www.bunnings.co.nz in New Zealand for store locations).

GSM International Pty Ltd bears reasonable, direct, expenses of claiming under the warranty in Australia. You may submit details and proof to a Bunnings store for consideration or contact our service agent below.

This warranty is provided in addition to other rights and remedies you may have under law: our goods come with guarantees which cannot be excluded under the Australian Consumer Law (if purchased in Australia) or the Consumer Guarantees Act 1993 (if purchased in New Zealand). You are entitled to replacement or refund for a major failure and to compensation for other reasonably foreseeable loss or damage. You are also entitled to have the goods repaired or replaced if the goods fail to be of acceptable quality and the failure does not amount to a major failure.

The warranty excludes damage resulting from product misuse or product neglect. The warranty covers domestic use only and does not apply to commercial applications.

This warranty is given by GSM International Pty Ltd

ABN: 53007682475

For Warranty and technical queries: 1300 373 199 Aus Or 0800 200 037 NZ

Warranty Exclusions

Damage to the base or diffuser or any part through accident, misuse or negligence.

G | S | M

Gerard Sourcing & Manufacturing

GSM International Ltd.

Consumer Service Centre :

Aus: 1300 373 199

NZ: 0800 200 037

GSM International Ltd has a policy of continual improvement throughout the product range.
As such the unit contained within may differ slightly from the unit illustrated on the pack.

MADE IN CHINA for GSM International Ltd.
Mistral is a registered trademark of GSM International Ltd.



Cat. No. MBF851
April 2020