



Cordless Handstick Vacuum Cleaner



Instruction Manual

Model: MWVC552

Important Safeguards

When using electrical appliances, in order to reduce the risk of fire, electric shock and/or injury, these basic safety precautions should always be followed:

For Your Safety

Read all instructions carefully, even if you are familiar with the appliance.

- This appliance is not intended for use by persons (including children) with reduced physical, sensory and mental capabilities, or lack of experience and knowledge, unless they have been given supervision or instruction concerning use of the appliance by a person responsible for their safety.
- Children should be supervised to ensure that they do not play with the appliance.
- This appliance is for household use only. Do not use this appliance for anything other than its intended use. Do not use in moving vehicles or boats. Do not use outdoors. Misuse may cause injury.
- Do not allow this appliance to be used as a toy. Close attention is necessary when used nearby children.
- Use only as described in this manual and only use manufacturer's recommended attachments.
- Do not use with damaged cord or plug.
- Do not handle charger or appliance with wet hands.
- Do not put any object into openings. Do not use with any opening blocked. Keep free of dust, lint, hair and anything that may reduce airflow.
- Keep hair, loose clothing, fingers and all parts of body away from openings and moving parts.
- Do not vacuum the following objects: toxic substances, flammable and explosive dangerous material, corrosive material and burning ash, matches, cigarette and combustible liquids, such as gasoline.
- Do not use the appliance to vacuum any dust harmful to health.
- Do not use without container and filter in place. Clean container and filter after picking up any perishable food items.
- Use only Handheld Vacuum Cleaner accessory, filter and charger.
- Do not vacuum water, liquids or other sharp objects like nails or drawing pins as they may damage the appliance.
- Do not pick up any objects which are smoking or burning, such as matches, cigarettes or hot ashes.
- Do not unplug the charger by pulling on the cord.
- Never carry the charger by the cord or to disconnect from an outlet; instead, grasp the charger and pull to disconnect. Do not pull cord around sharp edges or corners.
- Do not immerse the appliance, charger and cord in water or any other liquid.
- Always switch the appliance off when charging.
- Do not attempt to use the charger with any other product.
- The use of an extension cord is not recommended. Only plug the charger into a standard electrical outlet (230V or 240V outlet).
- Do not operate with a damaged charger and cord, or after the appliance has malfunctioned or been damaged in any manner.

Warning

Use only the charger supplied with this appliance to recharge this appliance.

If the power cord is damaged, the power cord must be replaced by the manufacturer, its service agent or similarly qualified persons in order to avoid a hazard.

The Product uses a Lithium-ion Battery. Take care when removing an old Battery from the Main Body of the Stick Vacuum.

Ensure that old, used Batteries are disposed of in the correct manner. These should not be put in the domestic waste. Contact your local authority for indication of a suitable method of disposal or to locate your nearest collection point.

This product has not been designed for any uses other than those specified in this booklet.

Save These Instructions

Features of Your Cordless Handstick Vacuum Cleaner

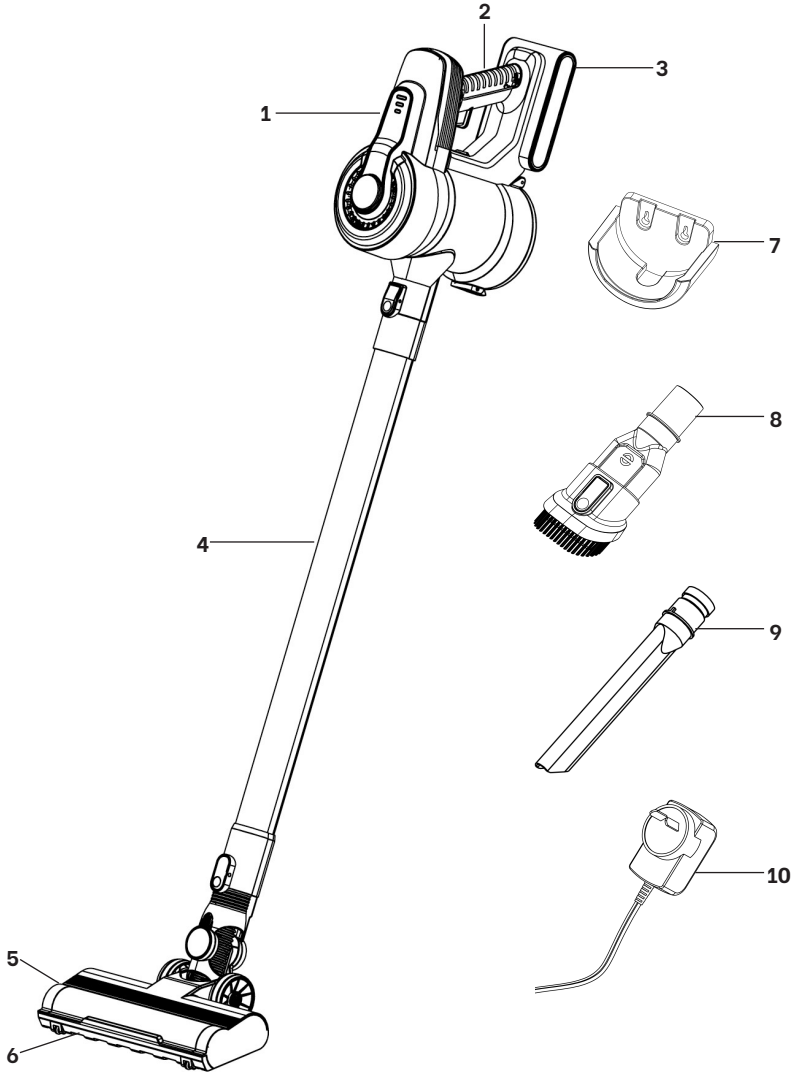

- 1. Main Unit
- 2. Handle
- 3. Removable Battery Pack
- 4. Extension Tube
- 5. Motorized Brush Head
- 6. LED Lights
- 7. Wall Mount
- 8. 2-in-1 Dusting Brush
- 9. Crevice Tool
- 10. Charger

Pack List

- 1 x Main Unit
- 1 x Battery Pack
- 1 x Extension Tube
- 1 x Motorized Brush Head
- 1 x Wall Mount
- 1 x 2-in-1 Dusting Brush
- 1 x Crevice Tool
- 1 x Charger

Main Unit

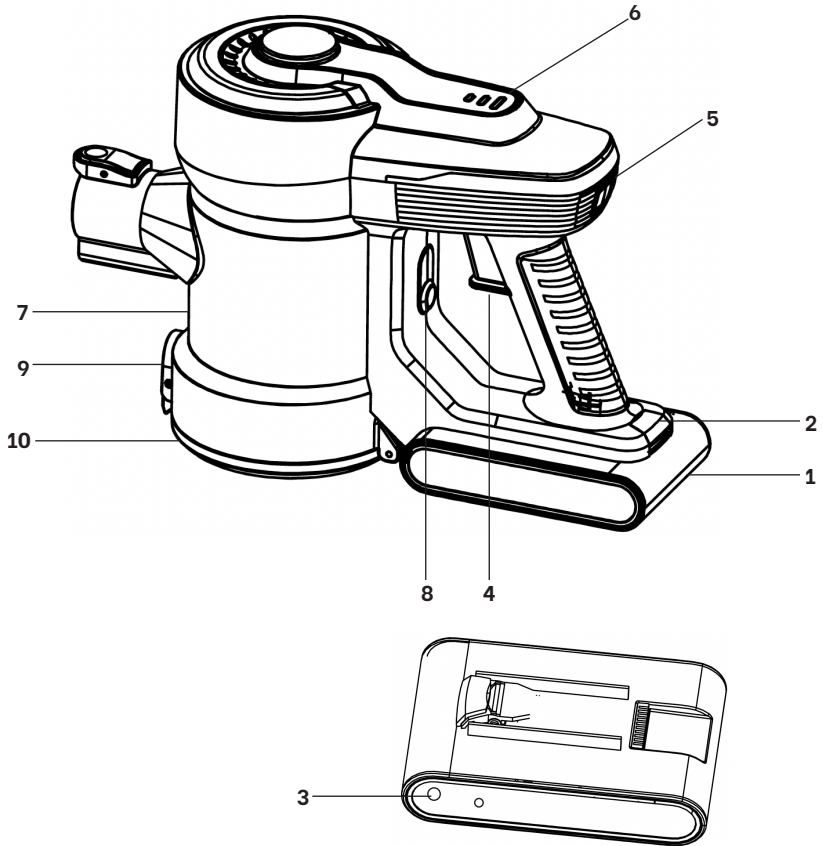

- 1. Battery Pack
- 2. Battery Release Button
- 3. Charging Socket
- 4. ON/OFF Button
- 5. Speed Control Button
- 6. Battery Level Indicator Lights
- 7. Dust Cup
- 8. Dust Cup Release Button
- 9. Dust Cup Cover Release Button
- 10. Dust Cup Cover

First Use

Checking the product and scope of delivery if you are not cautious when opening the packaging with a sharp knife or other pointed object, you may quickly damage the product.

- For this reason, be very careful when opening it.
1. Take the product out of the packaging.
 2. Check to make sure that all parts are included.
 3. Check whether the product or individual parts are damaged. If this is the case, do not use the product.

Basic cleaning

- Remove the packaging material and all plastic wrappings.
- Clean all parts of the product before first use as described in the chapter "Cleaning".

Operation

Charging the product

Caution: before using the product, the battery has to be fully charged.
Do not turn on the product during charging.

Note: This product must be used only with the battery charger provided with the product CZH015270050AUWH.

- To maintain a charge, keep the charger plugged into a standard a 230V – 240V power outlet. Ideally, A full charge cycle takes about 5 hours. A partial charge will reduce the service time. The charging adapter and the top of the appliance may become hot during the charge – this is normal.
- Once a single line of the battery level indicator flashes, turn off the product and connect the electric plug of the battery charger to a power outlet and the plug into the socket on the side of the battery.
- The three charging lines will light up in sequence and the blue light placed near the plug connection on the battery will flash.
- At the end of the recharge, the three lines will all be illuminated and the light near the plug connection on the battery will be blue and not flashing.
- Full recharge in about 5 hours – about 20 minutes working time in high speed – about 30 minutes working time in low speed.

- The battery can be recharged either attached to the Main Unit or detached from it. To detach the battery from the Main Unit, press the battery release button and remove it. (Fig.1)

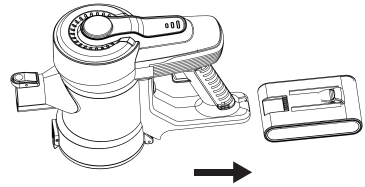

Fig.1

- To reposition the battery under the Main Unit, insert the battery into the grooves until you hear a click. (Fig.2)

Parts Assembly

Batteries Unit

Insert the batteries unit into the bottom of the machine and when it locked into the machine, you will hear the sound of connection. Pay attention to the direction. (Fig.2)

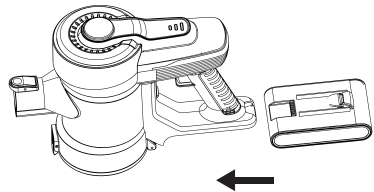



Fig.2

Dust cup assembly assembled with the Main unit

Connect the Main unit to the dust tank by aligning the arrow ↓ placed on the lower part of the motor, to the symbol  and by holding the tank turn the Main unit anticlockwise until you hear a click and the arrow ↓ is aligned to the symbol . (Fig.3)

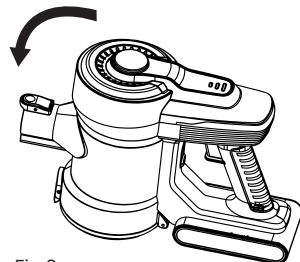

Fig.3

Connection of Extension Tube and Motorized Brush Head

Insert the upper part into lower connection of the extension tube and can hear the sound of locking. (Fig.4)

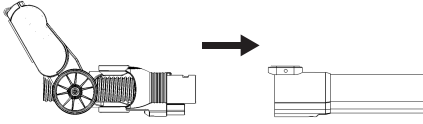

Fig.4

Connection of Main Unit and Extension Tube

Insert the upper ends into the main hole of the dust cup and can hear the locking sound. (Fig.5)

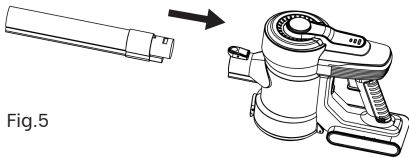

Fig.5

Connection of Motorized Brush Head and Main Unit

Insert the upper part of the Motorized Brush Head into the main hole of the Main Unit until hearing the locking sound. (Fig.6)

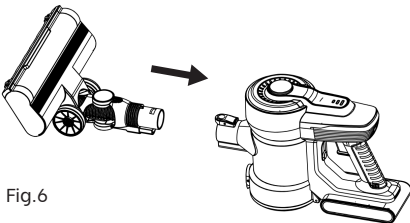

Fig.6

Connection of Crevice Tool and Dusting Brush with Main Machine

Insert the Dusting Brush and Crevice Tool into the main hole of the Main Unit. (Fig.7, Fig.8)

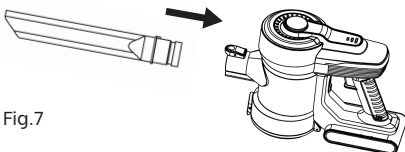

Fig.7

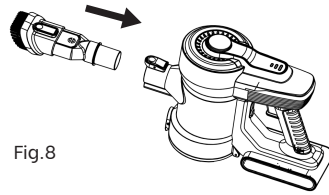

Fig.8

Connection of Dusting Brush and Crevice Tool with Extension Tube

Insert the Dusting Brush and Crevice Tool onto the Extension Tube until hearing the locking sound. (Fig.9, Fig.10)

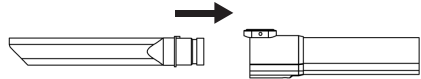

Fig.9

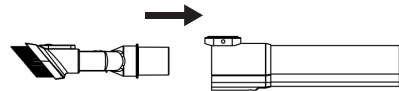

Fig.10

Wall Mount Installation

The product is equipped with a Wall Mount and relative fixing kit. The support only helps to keep the appliance sturdy when the tube and the brush are inserted. The appliance will not be attached to the support but only supported by it.

Mount the wall mounting bracket on the wall. Do not secure the bracket to drywall only. Secure the screws to a stud. Use the 2 screws provided. Mount at a recommended height of 120cm and no less than 100cm above the floor. Behind the mounting area. (Fig.11)

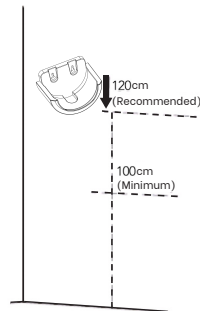

Fig.11

How to use

Warnings

This appliance can be used to vacuum only dry materials, it is not waterproof. Do not use it to vacuum liquids or wet dust. Do not use the product to vacuum hot dust or ash. Use the product as indicated on the manual. Do not use this product on concrete, asphalt or other rough surfaces. This appliance is for household use. Do not use to vacuum masonry dust and/or cement dust. Do not use or leave the product in too hot or too cool spaces, it is suggested to leave the product in environments from 0 to 35°C. Do not leave the product in sun light for too long.

After you are familiar with the assembly of this appliance and the use of the various accessories and their functions, you can now put this appliance to use.

The appliance works in two different ways.

As a stick vacuum cleaner simply using the Extension Tube and its accessories.

As a handheld vacuum cleaner simply using the accessories without the Extension Tube.

With the battery pack fully charged and the desired accessory selected and attached,

Press the ON/OFF Button on the vacuum motor head to start the appliance. The power indicator light illuminates. ON/OFF Button trigger once, ON, once more, OFF. (Fig.12)

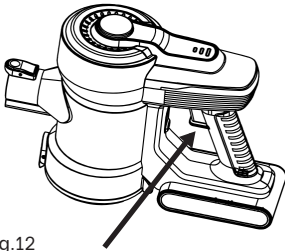

Fig.12

Press the Speed Control Button (+/-) on the vacuum motor head to select either Low or High speed. At Low speed the operating time is approximately 30 Minutes, at High speed 20 minutes. (Fig.13)

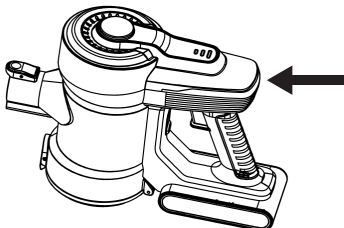

Fig.13

When a single line of the battery level indicator flashes, switch the appliance OFF, it is time to recharge the battery.

Warning: Never use this appliance to vacuum up liquids or water, it may damage this machine.

Use of 2-in-1 Dusting Brush

1. Insert the 2-in-1 Dusting Brush onto the main sucking hole, then push out the brush head of the 2-in-1 Dusting Brush and lock it, then you can clean the furniture, home appliances, book shelf, wardrobe, vanity table, PC keyboard and other places.
2. Pull back the brush head of 2-in-1 Dusting Brush and lock it, then you can clean bed, curtain, sofa and so on.

Use of Crevice Tool

Insert the Crevice Tool onto the main sucking hole, then can use it to clean crevice of sofa and base board.

Use of Motorized Brush Head

Insert the Motorized Brush Head onto end of the lower Extension Tube, then insert the upper end to the suction hole of the vacuum cleaner, then can clean parquet, carpet, tile and some other places.

Care and Maintenance

Main Unit, Motorized Brush, 2-in-1 Dusting Brush or Crevice Tool.

Use a damp cloth to wipe of any dirt deposits from the external brush head enclosure if need arises.

Do not use abrasive cleaning agents (scouring agents, diluting agents) because they can damage the synthetic surface of the device.

Warning: Don't let water enter into the motorized brush head as there are electrical terminations contained within and may irreparably damage.

Clean Dust Cup and Filter

In order to achieve the best performance, empty the dust cup and clean filter after each use.

1. Turn off the vacuum cleaner.
2. Press the upper Dust Cup Release Button to release the dust cup assembly unit then press the lower Dust Cup Cover Release Button to release the Dust Cup Cover. It is recommended to clean the dust cup after using every time.
- Press the Dust Cup Release Button to disconnect it from the dust tank and rotate the tank clockwise until the arrow ↓ is aligned to the symbol ▣ and extract it (Fig.14). Then press the lower Dust Cup Cover Release Button to release the dust cup lower cover. To empty the dust tank. (Fig.15)

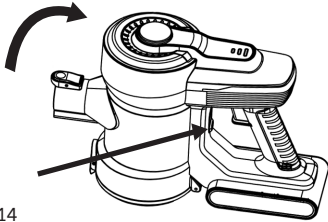

Fig.14

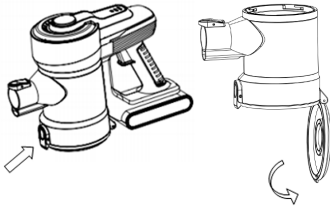

Fig.15

- Remove the tissue filter and the filter cover (Fig.16) and wash them in water. Let them completely dry at the air before reassemble them. The tissue filter must be repositioned.



Fig.16

Tips: Clean the filter under running water and dry it under sunlight. (Fig.17)

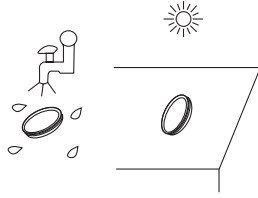

Fig.17

- Be sure the filter and all parts are well positioned before reconnect the dust tank to the main body.

How to Clean the Motorized Brush

Turn the brush upside down to have the bristles facing up, push the lock chip on the left of the brush downwards, moving it towards the symbol ▣ (Fig.18). In this way the cylinder with the bristles is raised and it is possible to remove it. Wash it with water and allow to dry completely. To reinsert the cylinder, insert the round end into the right side of the brush and press the left side down until you hear a click. (Fig.19)

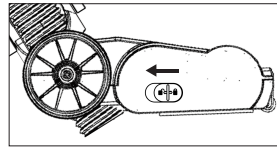

Fig.18

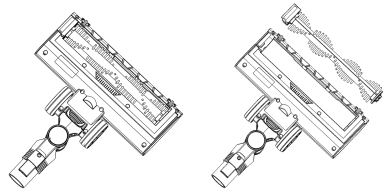

Fig.19

Note: After long period using, the bristle may be jammed by hair or something similar, need to clean it in time in order to make the machine work efficiently.

Troubleshooting

Before returning product that may be faulty, please check below Troubleshooting.

Problem	Solution
Vacuum will not work	<ol style="list-style-type: none">1. The vacuum may have run out of battery power, make sure it is fully charged.2. Push charger securely into electrical outlet, try another outlet or check circuit breaker.
Vacuum will not pick up dust or suction power is weak	<ol style="list-style-type: none">1. Empty dust cup and clean or change filters.2. Make sure cleaner is fully powered, charge battery.3. Remove clogs that restrict the airflow.
The power button does not work while charging	It is normal when the vacuum is in charging mode, the power button will be locked for power off protection.

Specifications

Model:.....MWVC552

Charging time:.....approx 5 hours

Operating time:High speed: about 20 minutes

Low speed: about 30 minutes

Rechargeable battery: 22.2V 2200mAh

Battery charger

- Input:100-240 V, 50 Hz

- Output:DC 27V 500mA

Warning: As a result of continual improvements, the design and specifications of the product within may differ slightly to the unit illustrated from the packaging.

Warranty

This product is guaranteed to be free from defects in workmanship and materials, including parts and unless otherwise specified, for a period of 12 months from the date of purchase.

Defects that occur within the warranty period, under normal use and care, will be repaired, replaced or refunded at our discretion.

The benefits conferred by this warranty are in addition to all rights and remedies in respect of the product that the consumer has under the Competition and Consumer Act 2010 and similar state and territory laws.

Our goods come with guarantees that cannot be excluded under the Australian Consumer Law. You are entitled to a replacement or refund for a major failure and for compensation for any other reasonably foreseeable loss or damage. You are also entitled to have the goods repaired or replaced if the goods fail to be of acceptable quality and the failure does not amount to a major failure.

Proof of Purchase

This warranty is valid for the original purchase and is not transferable. Please keep your purchase docket, tax invoice or receipt as the best proof of purchase, and as proof of date on which the purchase was made.

Extent of Warranty

This warranty is limited to defects in workmanship and materials, including parts. All defective products or parts will be repaired, replaced or refunded. This warranty does not cover batteries or any other consumable items.

Normal wear and tear

This warranty does not cover normal wear to the products or parts.

Exclusions

This warranty does not cover:

- Any defects caused by an accident, misuse, abuse, improper installation or operation, lack of reasonable care, unauthorised modification, loss of parts, tampering or attempted repair by a person not authorised by the distributor.
- Any product that has not been installed, operated or maintained in accordance with the manufacturer's operating instructions provided with the product.
- Any product that has been used for purposes other than domestic use.
- Any damage caused by improper power input or improper cable connection.

To make a claim

This warranty against defects is given by: **Woolworths Group**

Address: 1 Woolworths Way, Bella Vista, NSW 2153

Email: www.woolworths.com.au

Telephone: 1300 767 969

If a defect in the product appears within the nominated warranty period (The identified period on the packaging/Instructions), cease using the product, and return the product **to the place of purchase**. If we agree that a defect covered by this warranty has occurred, you are entitled for replacement or refund of the product.

When making a return, please ensure the product is properly packaged to ensure that no damage occurs to the product during transit.

Where a claim for warranty extends beyond place of purchase replacement /refund (Installed products requiring service repair) please contact:

Telephone: 1300 373 199 (For warranty repairs and technical support)

Supplier Name: GSM Retail Australia Pty Ltd

Supplier Address: 142-144 Fullarton Road, Rose Park, SA 5067

Email: admin@gsmretailgroup.com

G | S | M

Gerard Sourcing & Manufacturing

GSM Retail Group

Consumer Service Centre : 1300 373 199

GSM Retail Group has a policy of continual improvement throughout the product range.
As such the unit contained within may differ slightly from the unit illustrated on the pack.

MADE IN CHINA for GSM Retail Group
Mistral is a registered trademark of GSM Retail Group
142-144 Fullarton Road, Rose Park, SA 5067



Cat. No. MWVC552
June 2023