

# mīstral

## 60cm Flex Zone Induction Cooktop

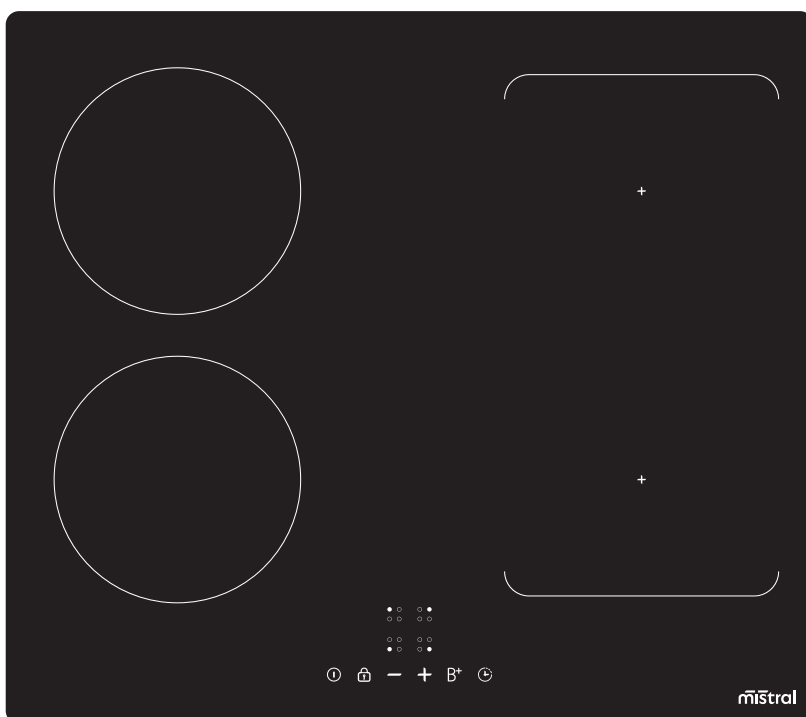

## Instruction Manual

Model: MBCI625-4FG/ MBCI625-4FG-F

v2 December 2025

# Thank you.

When you step up to a Mistral product, you can rest assured you're making the better choice. Because when you buy a Mistral product you're buying a brand Australian Households have trusted since 1968.



## Contents

<b>Safety Warnings</b>	<b>2</b>
Installation	2
Operation and Maintenance	2
<b>Description of the Appliance</b>	<b>4</b>
Top View	4
The Control Panel	4
<b>Using your Induction Hob</b>	<b>5</b>
<b>Installation</b>	<b>9</b>
Selection of installation equipment	9
Before using the New Hob	12
<b>Care and Cleaning</b>	<b>13</b>
<b>Trouble Shooting Tips</b>	<b>14</b>
<b>Failure Display and Inspection</b>	<b>15</b>
<b>Technical Specification</b>	<b>16</b>
<b>Environmental Note</b>	<b>16</b>
<b>Preventing Glass Cracks</b>	<b>17</b>

### NOTE:

- Reviewing the section on Troubleshooting Tips will help you solve some common problems by yourself.
- If you cannot solve the problems by yourself, please ask for help from a professional technician.
- The manufacturer, following a policy of constant development and updating of the product, may make modifications without giving prior notice.
- If lost or out-of-date, you can receive a new user manual from the manufacturer or responsible vendor.

# Safety Warnings

 Please read the following instructions carefully before using the appliance.

## Installation

---

### Electrical Shock Hazard

- Disconnect the appliance from the mains electricity supply before carrying out any work maintenance on it.
- Connection to a good earth wiring system is essential and mandatory.
- Means for disconnection must be incorporated in the fixed wiring in accordance with the wiring rules.
- Alterations to the domestic wiring system must only be made by a qualified electrician.
- Failure to follow this advice may result in electrical shock or death.

### Cut Hazard

- Take care panel edges are sharp.
- Failure to use caution could result in injury or cuts.

### Important Safety Instructions

- Read these instructions carefully before installing or using this appliance.
- No combustible material or products should be placed on this appliance at any time.
- Please make this information available to the person responsible for installing the appliance as it could reduce your installation costs.
- In order to avoid a hazard, this appliance must be installed according to these instructions for installation.
- This appliance is to be properly installed and earthed only by a suitably qualified person.
- This appliance should be connected to a circuit which incorporates an isolating switch providing full disconnection from the power supply.
- **WARNING:** Use only hob guards designed by the manufacturer of the cooking appliance or indicated by the manufacturer of the appliance in the instructions for use as suitable or hob guards incorporated in the appliance. The use of inappropriate guards can cause accidents.
- Failure to install the appliance correctly could invalidate any warranty or liability claims.
- Regarding the details of installation, thanks to refer to the section 'Installation'.

## Operation and Maintenance

---

### Electrical Shock Hazard

- Do not cook on a broken or cracked cooktop. If the cooktop surface is broken or cracked, switch the appliance off immediately at the mains power supply (wall switch) and contact a qualified technician.
- Switch the cooktop off at the wall before cleaning or maintenance.
- Failure to follow this advice may result in electrical shock or death.

### Health Hazard

- This appliance complies with electromagnetic safety standards.

### Hot Surface Hazard

- During use, accessible parts of this appliance will become hot enough to cause burns.
- Do not let your body, clothing or any item other than suitable cookware contact the ceramic glass until the surface is cool.
- Metallic objects such as knives, forks, spoons and lids should not be placed on the hob surface since they can get hot.
- Children less than 8 years of age shall be kept away unless continuously supervised.
- Handles of saucepans may be hot to touch. Check saucepan handles do not overhang other cooking zones that are on. Keep handles out of reach of children.
- Failure to follow this advice could result in burns and scalds.

### Cut Hazard

- The razor-sharp blade of a cooktop scraper is exposed when the safety cover is retracted. Use with extreme care and always store safely and out of reach of children.
- Failure to use caution could result in injury or cuts.

### Important safety instructions

- Never leave the appliance unattended when in use. Boiling over causes smoking and greasy spillovers that may ignite.
- Never use your appliance as a work or storage surface.
- Never leave any objects or utensils on the appliance.

- Never use your appliance for warming or heating the room.
- After use, always turn off the cooking zones and the cooktop as described in this manual (i.e. by using the touch controls).
- Do not allow children to play with the appliance or sit, stand, or climb on it.
- Do not store items of interest to children in cabinets above the appliance. Children climbing on the cooktop could be seriously injured.
- Do not leave children alone or unattended in the area where the appliance is in use.
- Children or persons with a disability which limits their ability to use the appliance should have a responsible and competent person to instruct them in its use. The instructor should be satisfied that they can use the appliance without danger to themselves or their surroundings.
- Do not repair or replace any part of the appliance unless specifically recommended in the manual. All other services should be done by a qualified technician.
- Do not use a steam cleaner to clean your cooktop.
- Do not use pans with jagged edges or drag pans across the glass surface as this can scratch the glass.
- Do not use scourers or any other harsh abrasive cleaning agents to clean your cooktop, as these can scratch the ceramic glass.
- If the supply cord is damaged, it must be replaced by the manufacturer, its service agent or similarly qualified persons in order to avoid a hazard.
- This appliance is intended to be used in a domestic household environment only! Commercial use of any kind is not covered under the manufacturer's warranty!
- **WARNING:** The appliance and its accessible parts become hot during use.
- Care should be taken to avoid touching heating elements.
- Children less than 8 years of age shall be kept away unless continuously supervised.
- This appliance can be used by children aged from 8 years and above and persons with reduced physical, sensory or mental capabilities or lack of experience and knowledge if they have been given supervision or instruction concerning use of the appliance in a safe way and understand the hazards involved.
- Children shall not play with the appliance. Cleaning and user maintenance shall not be made by children without supervision.
- **WARNING:** Unattended cooking on a hob with fat or oil can be dangerous and may result in fire. NEVER try to extinguish a fire with water, but switch off the appliance and then cover flame e.g. with a lid or a fire blanket.
- **WARNING:** Danger of fire: do not store items on the cooking surfaces.
- **WARNING:** If the surface is cracked, switch off the appliance to avoid the possibility of electric shock, for hob surfaces of glass-ceramic or similar material which protect live parts.
- A steam cleaner is not to be used.
- The appliance is not intended to be operated by means of an external timer or separate remote-control system.
- **CAUTION:** The cooking process has to be supervised continuously.
- Power cord can't accessible after installation.

Congratulations on the purchase of your new induction hob. We recommend that you spend some time reading this Instruction / Installation Manual in order to fully understand how to install correctly and operate it.

Read all the safety instructions carefully before use and keep this Instruction / Installation Manual for future reference.

# Description of the Appliance

## Top View

1. Max. 2100W Zone
2. Max. 1500W Zone
3. Max. 2100W Zone
4. Max. 1500W Zone
5. Max. 3000W Zone
6. Control Panel

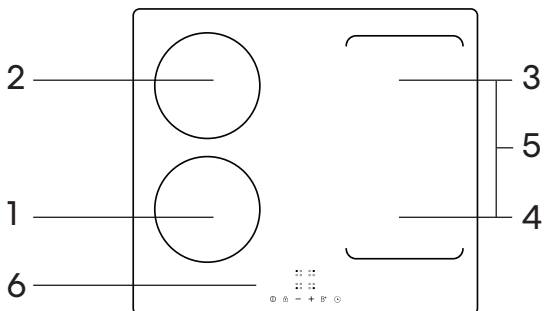

## The Control Panel

1. ON/OFF
2. Child Lock
3. Power / Timer Regulating Control
4. Booster Control
5. Timer Control
6. Heating Zone Selection Control
7. Timer Display
8. Flexible zone function

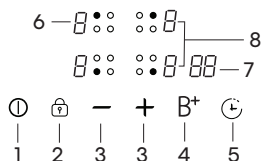





No.	Reference	Description
1		ON/OFF: Turn on or turn off the appliance.
2		Child lock: Touch it to lock keys (display show "Lo") and press and hold for a while to unlock. When it is activated, none of the other buttons can be activated except for ON/OFF.
3		UP: Increase the power level or increase the time.
4		DOWN: Reduce the power level or decrease the time.
5		Booster: Activate the boost function, the selected cooking zone will work for 5 minutes with max power.
6		Timer: You can use it as a simple minute minder or timer to control one or more zones. Max timer setting is 99min.
7		The top left burner
8		The bottom left burner
9		The top right burner
10		The bottom right burner
11		Display: It shows power level, error code and hob status.
12		Timer display





# Using your Induction Hob

## To Start Cooking



After power on, the buzzer beeps once, all the indicators light up for 1 second then go out, indicating that the hob has entered the state of standby mode.

<p>1. Touch the ON/OFF switch, all the indicators show '—'.</p> <p>If you don't choose a heat setting within 1 minute, the induction hob will automatically switch off, you will need to start again at step 1.</p>	
<p>2. Place a suitable pan on the cooking zone that you wish to use. Make sure the bottom of the pan and the surface of the cooking zone is clean and dry.</p>	
<p>3. Touching the heating zone selection control, and an indicator next to the key will flash.</p>	
<p>4. Select a heat setting by touching the '+', '-' control. If you don't choose a heat setting within 1 minute, the induction hob will automatically switch off, you will need to start again at step 1. You can modify the heat setting at any time during cooking.</p>	

## When you have finished cooking

<p>1. Touch the heating zone selection that you wish to switch off.</p>	
<p>2. Turn the cooking zone off by scrolling down to '0' control. Make sure the display shows '0'.</p>	
<p>3. Turn the whole cooktop off by touching the ON/OFF control.</p>	
<p>4. Beware of hot surface          "H" lights up on the power display to indicate that a particular zone is very hot and should not be touched. It will disappear when the surface has cooled down to a safe temperature. It can also be used as an energy saving function if you want to pre-heat further pans, use the zone that is still displays "H".</p>	

## Using Boost Function

<p>Activate the boost function</p> <ol style="list-style-type: none"> <li>1. Select the zone with boost function.</li> <li>2. Touching the 'boost' key, then the display shows 'b'.</li> </ol>	
<p>Cancel boost function</p> <ol style="list-style-type: none"> <li>1. Select the zone with boost function.</li> <li>2. Touching the 'minus' key control to cancel the Boost function, and select the level you want to set.</li> <li>3. Boost function can only last for 5 minutes, after that the zone will go to level 9 automatically.</li> </ol>	

## Using Child Lock Function

- You can lock the controls to prevent unintended use (for example children accidentally turning the cooking zones on).
- When the controls are locked, all the controls except the ON/OFF control are disabled.

<p><b>To lock the controls</b> Touch the key lock control. The timer indicator will show 'Lo'.</p>	
<p><b>To unlock the controls</b></p> <ol style="list-style-type: none"> <li>1. Make sure the hob is turned on.</li> <li>2. Touch and hold the key lock control for 3 seconds.</li> <li>3. You can now start using your hob.</li> </ol>	







**!** When the hob is in lock mode, all the controls are disabled except the ON/OFF, you can always turn the hob off with the ON/OFF control in an emergency, but you shall unlock the hob first in the next operation.

## Using the Timer





You can use the timer in two different ways:



- You can use it as a minute minder: Under the working conditions, if no cooking zone is selected for timing operation, when the setting time is reached, the cooking zone will not close automatically.
- You can use it as cut-off timer: If one or more cooking zone is selected for timing operation, when the setting time is reached, the cooking zone will close automatically.
- You can set the timer up to 99 minutes.

### Using the timer as a Minute Minder



<p>1. Make sure the cooktop is turned on. And zone selection key is not activated (zone indication '●' is not flashing). Note: you can set minute minder before or after cooking zone power setting is finished.</p>	
<p>2. Touch timer key, '10' will show in the timer display and '0' will flash .</p>	
<p>3. Set the time by touching the '-', '+' control of timer.</p>	
<p>4. Touch timer control again, then '1' will flash.</p>	
<p>5. Set the time by touching the '-', '+' control.</p>	
<p>6. When the timer is set, it will begin to count down immediately. The display will show the remaining time.</p>	
<p>7. Buzzer will beep for 30 seconds and the timer indicator shows '- -' when the setting time finished.</p>	

### Using the timer to switch off one or more cooking zones



<p>1. Touching the heating zone selection control that you want to set the timer for.</p>	
<p>2. Touch timer control, the '10' will show in the timer display, and the '0' flashes. Zone indication '●' is flashing.</p>	
<p>3. Set the time by touching the '-', '+' control.</p>	
<p>4. Touch timer control again, the '1' will flash.</p>	
<p>5. Set the time by touching the '-', '+' control.</p>	

<p>6. When the time is set, it will begin to count down immediately. The display will show the remaining time.</p> <p>NOTE: there will be a red dot in the bottom right corner of the power level indication which indicates that zone is selected.</p>	
<p>7. When the cooking timer expires, the corresponding cooking zone will be switched off automatically.</p> <p>NOTE: other cooking zones will keep operating if they are turned on previously.</p>	

### If the timer is set on more than one zone

<p>1. When you set timer for several cooking zones, red dots of the relevant cooking zones are indicated. The timer display shows the min. timer and the dot of the corresponding zone flashes.</p>	<p>(set to 15 minutes) </p> <p>(set to 30 minutes) </p>
<p>2. Once the countdown timer expires, the corresponding zone will switch off. Then it will show the new min. timer, and the dot of the corresponding zone will flash.</p> <p>NOTE: touch the heating zone selection control, the corresponding timer will be shown in the timer indicator.</p>	

### Canceling the timer

<p>1. Touching the heating zone selection control that you want to cancel the timer.</p>	
<p>2. Touching the timer control, the indicator will flash.</p>	
<p>3. Touch the UP/DOWN control to set the timer to '00', the timer is canceled.</p>	

### Using the Flexible Zone Function

1. This area can be used as a single zone or as two individual zones depending on the cooking needs in each situation
2. It is made of two independent inductors that can be controlled separately. When the flexible zone is working, only the zone covered by the cookware is activated.
3. To ensure that the cookware is detected and heat is distributed evenly, make sure to place the cookware centered on the cooking zone.
4. One hob with more than one flexible zone, it is not recommended to use several zones at the same time for a single pan.
5. Make sure to place the cookware centered on the single cooking zone. Do not put the pot in the middle of the bridge area. The ideal recipe is an oval or rectangular saucepan, or a saucepan.

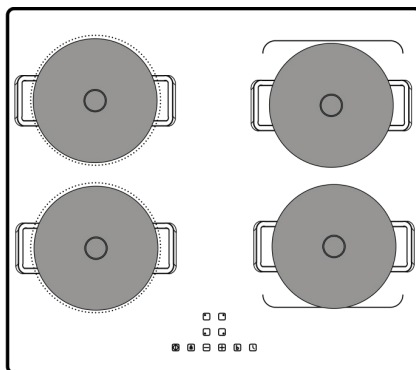
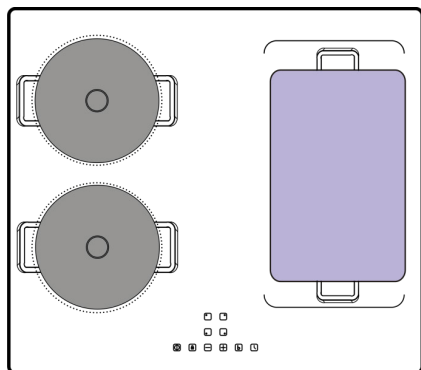

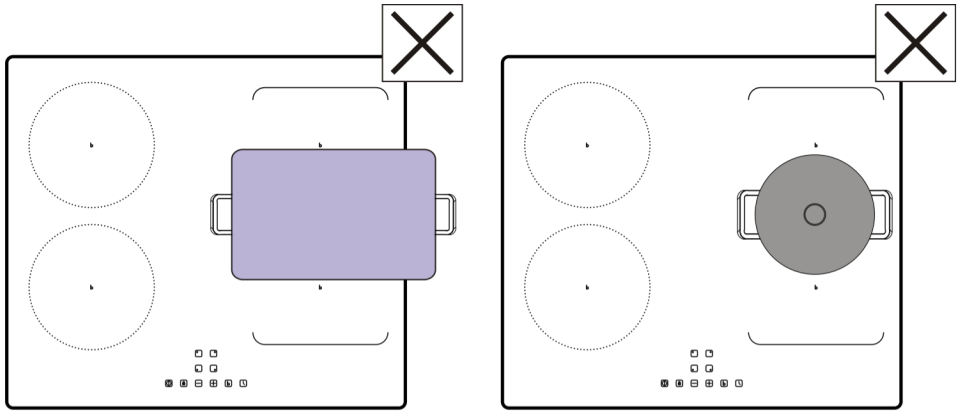

6. Press both the control keys of the corresponding flexible zone (top right and bottom right) at the same time, the flexible zone will be activated, and the flexible zone will display as below image, then you can also use UP/DOWN selection control to adjust the power level and the Booster function for the flexible zone you choose. Press both keys again to exit the flexible zone function.

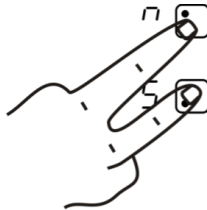

### Auto shutdown protection

Auto shutdown is a safety protection function for your induction hob. This occurs whenever you forget to switch off a cooking zone. The default shutdown times are shown in the table below:

Power level	1	2	3	4	5	6	7	8	9
Default working time (hour)	8	8	8	4	4	4	2	2	2

When the pot is removed, the induction hob can stop heating immediately and the hob automatically switch off after 1 minute.

### Residual heating warming

When the hob has been operating for some time, there will be some residual heat. The letter 'H' appears to warn you to keep away from it.

### Heat settings

Heat setting	Suitability
1 - 2	Delicate warming for small amounts of food. Melting chocolate, butter, and foods that burn quickly. Gentle simmering. Slow warming
3 - 4	Reheating, rapid simmering, cooking rice
5 - 6	Pancakes
7 - 8	Sauteing, cooking pasta
9	Stir-frying, searing, bringing soup to the boil, boiling water

# Installation

## Selection of installation equipment

- Cut out the work surface according to the sizes shown in the drawing.
- For the purpose of installation and use, a minimum of 50mm space shall be preserved around the hole.
- Be sure the thickness of the work surface is at least 30mm. Please select heat-resistant work surface material to avoid larger deformation caused by the heat radiation from the hotplate.
- The unit should be placed on a stable, smooth surface (use the packaging). Do not apply force onto the controls protruding from the hob.
- Put a towel or cloth on the work surface. Place the hob glass panel down on the protected surface.
- Apply the strip seal, supplied with the hob, which is for sealing it onto the work surface.
- Do not use silicone. Apply the seal to the edge of the bottom of the hob, leaving about 3mm from the edge of glass. Apply the seal all around the circumference.
- Cut any excess and bring the two ends of the seal together so they match.

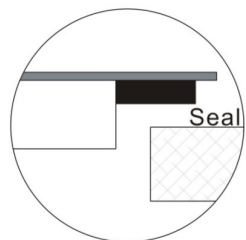
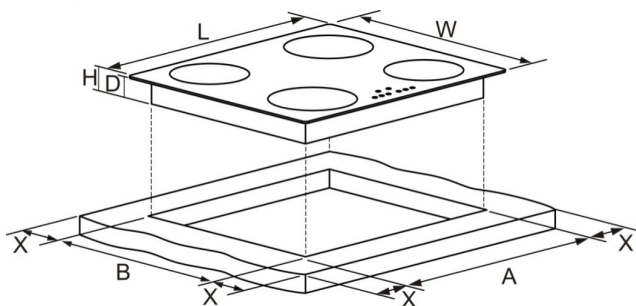
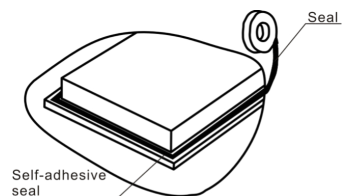
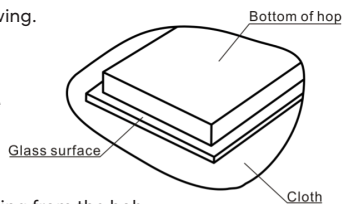

L(mm)	W(mm)	H(mm)	D(mm)	A(mm)	B(mm)	X(mm)
590	520	60	56	560	490	50

**Warning:** The work surface material must use the impregnated wood or other insulation material.

The kitchen units that are in direct contact with the appliances must be heatproof (min. 95°).

The appliance can be installed on a work surface with a thickness of between 30 and 40mm and near to walls, which are higher than the work surface, maintaining a minimum distance of 100 mm.

Carry out all cutting of the unit and work surface then carefully remove shavings or sawdust before inserting the appliances.

To ensure correct ventilation of the hob please comply with the dimensions show in figures.

Always refer to the manufacturer for specific instructions.

Make sure the surface is level and square and that no part interferes with the space required for installation.

Under any circumstance, make sure the hob is well ventilated and the air inlet and outlet are not blocked. Ensure the hob is in good working state.

Note: The safety distance between the hotplate and the cupboard above the hotplate should be at least 760mm.

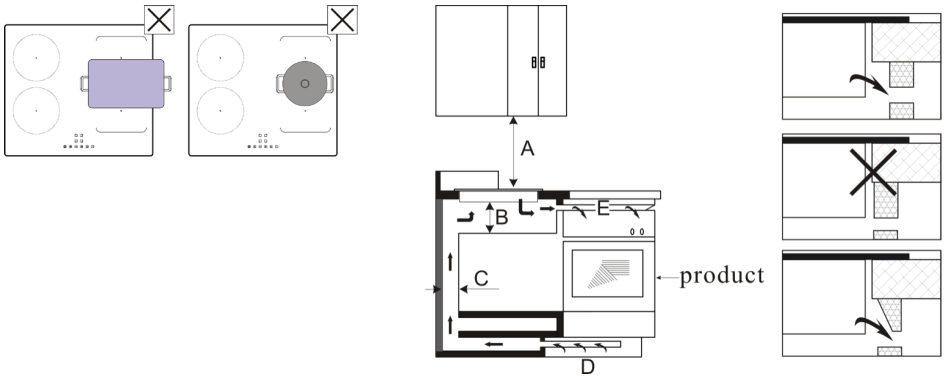

A (mm)	B (mm)	C (mm)	D	E
760	50 mini	20 mini	Air intake	Air exit 5mm

### Before you install the hob, make sure that

- The work surface is square and level, and no structural members interfere with space requirements.
- The work surface is made of a heat-resistant material.
- If the hob is installed above an oven, the oven has a built-in cooling fan.
- The installation will comply with all clearance requirements and applicable standards and regulations.
- A suitable isolating switch providing full disconnection from the mains power supply is incorporated in the permanent wiring, mounted and positioned to comply with the local wiring rules and regulations.
- The isolating switch must be of an approved type and provide a 3 mm air gap contact separation in all poles (or in all active [phase] conductors if the local wiring rules allow for this variation of the requirements).
- The isolating switch will be easily accessible to the customer with the hob installed.
- You consult local building authorities and by-laws if in doubt regarding installation.
- You use heat-resistant and easy-to-clean finishes (such as ceramic tiles) for the wall surfaces surrounding the hob.
- Lower part of induction cooker ambry must install the product such as oven, or close with board.

### When you have installed the hob, make sure that

- The power supply cable is not accessible through cupboard doors or drawers.
- There is adequate flow of air from outside the cabinetry to the base of the hob.
- If the hob is installed above a drawer or cupboard space, a thermal protection barrier is installed below the base of the hob.
- The isolating switch is easily accessible by the customer.

### Before locating the fixing brackets

- The unit should be placed on a stable, smooth surface (use the packaging). Do not apply force onto the controls protruding from the hob.

### Locating the fixing brackets

- Fix the brackets on the left side and right side by screw. Put the induction hob in the cut-out cabinet.

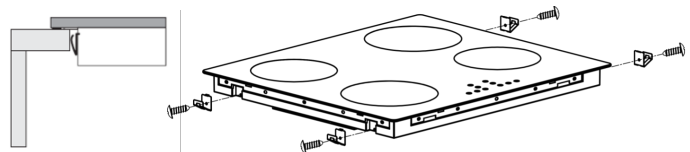

## Cautions

- The hob must be installed by qualified personnel or technicians, we have professionals at your service. Please never conduct the operation by yourself.
- Do not mount the hob above cooling equipment, dishwashers and tumble dryers.
- The hob should be installed such that better heat radiation can be ensured to enhance its reliability.
- The wall and induced heating zone above the work surface shall withstand heat.
- To avoid any damage, the sandwich layer and adhesive must be resistant to heat.
- A steam cleaner is not to be used.
- This hob can be connected only to a supply with system impedance no more than 0.427 ohm. In case it is necessary, please consult your supply authority for system impedance information.

## Connecting the hob to the mains power supply

**!** This hob must be connected to the mains power supply only by a suitably qualified person. Before connecting the hob to the mains power supply, check that:

1. The domestic wiring system is suitable for the power drawn by the hob.
2. The voltage corresponds to the value given in the rating plate.
3. The power supply cable sections can withstand the load specified on the rating plate. To connect the hob to the mains power supply, do not use adapters, reducers, or branching devices, as they can cause overheating and fire.

The power supply cable must not touch any hot parts and must be positioned so that its temperature will not exceed 75°C at any point.

**!** Check with an electrician whether the domestic wiring system is suitable without alterations. Any alterations must only be made by a qualified electrician.

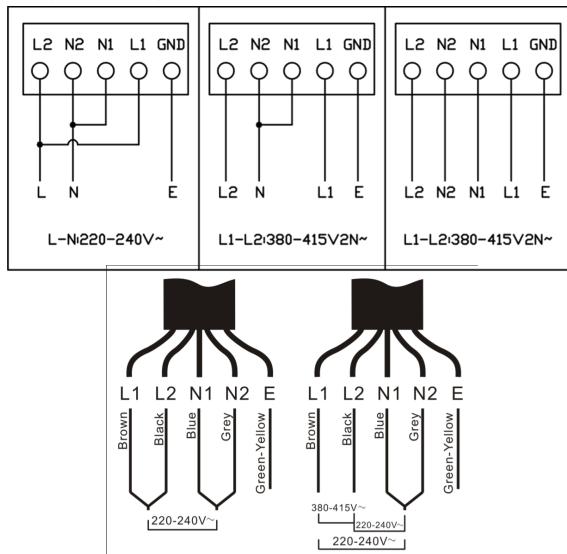

- Note: The appliance installation must be carried out by a qualified electrician.
- Ensure the safety circuit-breaker and the electrical system are able to withstand the power current is not less than 32A, refer to the rating label on appliance.
- If the cable is damaged or needs replacing, this should be done by an after-sales technician using the proper tools, so as to avoid any accidents.
- If the appliance is being connected directly to the mains supply, an omnipolar circuit-breaker must be installed with a minimum gap of 3mm between the contacts.
- The installer must ensure that the correct electrical connection has been made and that it complies with safety regulations.
- The cable must not be bent or compressed.
- The cable must be checked regularly and only replaced by a proper qualified person.

## Before using the New Hob

- Read this guide, taking special note of the "Safety Instructions" section.
- Remove any protective film that may still be on your induction hob.

### A Word on Induction Cooking

Induction cooking is a safe, advanced, efficient, and economical cooking technology. It works by electromagnetic vibrations generating heat directly in the pan, rather than indirectly through heating the glass surface. The glass becomes hot only because the pan eventually warms it up.

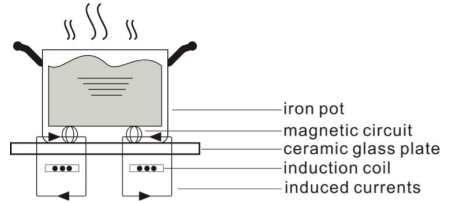

### Using the Touch Controls

- The controls respond to touch, so you don't need to apply any pressure.
- Use the ball of your finger, not its tip.
- You will hear a beep each time a touch is registered.
- Make sure the controls are always clean, dry, and that there is no object (e.g. a utensil or a cloth) covering them. Even a thin film of water may make the controls difficult to operate.

### Choosing the right cookware

- Only use cookware with a base suitable for induction cooking. Look for the induction symbol on the packaging or on the bottom of the pan.
- You can check whether your cookware is suitable by carrying out a magnet test. Move a magnet towards the base of the pan. If it is attracted, the pan is suitable for induction.
- If you do not have a magnet:
  1. Put some water in the pan you want to check.
  2. Follow the steps under 'To start cooking'.
  3. If 'L' does not flash in the display and the water is heating, then the pan is suitable.
- Cookware made by the following materials is not suitable: pure stainless steel, aluminum or copper without a magnetic base, glass, wood, porcelain, ceramic, and earthenware.

Size of burner (diameter/mm)	The minimum cookware (diameter/mm)
180	140
200x380	200x380

- The pots and pans must be placed precisely in the middle of the cooking area.
- In some cooking areas an internal diameter is indicated, with a lighter outline, which advises the user to go to a smaller cooking area, if available, with smaller diameter pan. This is to obtain optimum performance and efficiency. You can however use pans with smaller diameters than this limit.

Optimization cooking area

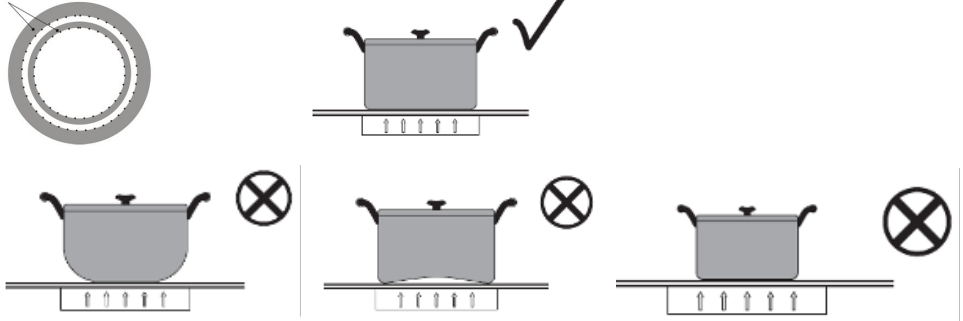

# Care and Cleaning

The settings below are guidelines only. The exact setting will depend on several factors, including your cookware and the amount you are cooking. Experiment with the cooktop to find the settings that best suit you.

What?	How?	Important!
Everyday soiling on glass (fingerprints, marks, stains left by food or non-sugary spillovers on the glass)	<ol style="list-style-type: none"> <li>1. Switch the power to the cooktop off.</li> <li>2. Apply a cooktop cleaner while the glass is still warm (but not hot!)</li> <li>3. Rinse and wipe dry with a clean cloth or paper towel.</li> <li>4. Switch the power to the cooker back on.</li> </ol>	<p>When the power to the cooktop is switched off, there will be 'no hot surface' indication but the cooking zone may still be hot!</p> <p>Heavy-duty scourers, some nylon scourers and harsh/abrasive cleaning agents may scratch the glass. Always read the label to check if your cleaner or scourer is suitable.</p> <p>Never leave cleaning residue on the cooktop: the glass may become stained</p>
Boil overs, melts, and hot sugary spills on the glass	<p>Remove these immediately with a fish slice, palette knife or razor blade scraper suitable for induction glass cooktops, but beware of hot cooking zone surfaces:</p> <ol style="list-style-type: none"> <li>1. Switch the power to cooktop off at the wall.</li> <li>2. Hold the blade or utensil at a 30° angle and scrape the soiling or spill to a cool area of the cooktop.</li> <li>3. Clean the soiling or spill up with a dish cloth or paper towel.</li> <li>4. Follow steps 2 to 4 for 'Everyday soiling on glass' above.</li> </ol>	<p>Remove stains left by melts and sugary food or spillovers as soon as possible. If left to cool on the glass, they may be difficult to remove or even permanently damage the glass surface.</p> <p>Cut hazard: when the safety cover is retracted, the blade in a scraper is razor-sharp. Use with extreme care and always store safely and out of reach of children.</p>
Spillovers on the touch control	<ol style="list-style-type: none"> <li>1. Switch the power to the cooktop off.</li> <li>2. Soak up the spill.</li> <li>3. Wipe the touch control area with a clean damp sponge or cloth.</li> <li>4. Wipe the area completely dry with a paper towel.</li> <li>5. Switch the power to the cooktop back on.</li> </ol>	<p>The cooktop may beep and turn itself off, and the touch controls may not function while there is liquid on them. Make sure you wipe the touch control area dry before turning the cooktop back on.</p>

# Preventing Glass Cracks

Despite the sturdiness of the glass surface of the cooktop, it is important to understand that it could be vulnerable to the following specific factors that can result in cracks of the glass surface.

1. **Proper Installation:** Follow precise installation guideline as per this instruction manual. If the cut-out dimension and tolerance aren't met, then there is a risk of the glass fracturing due to expansion and contraction.
2. **Managing Thermal Stress:** Glass is very sensitive to temperature changes. Always let the cooktop to cool down completely before performing any cleaning. Avoid placing extremely hot pans directly on a cold surface of the cooktop. Gradually adjust heat settings to prevent extreme temperature fluctuations.
3. **Careful Cookware Handling:** To prevent impact damages, handle the cookware gently when placing them on the cooktop. Avoid dragging heavy pots across the surface, as this may cause glass scratches and weaken its integrity.
4. **Distributing Weight Evenly:** Distributing weight evenly across the cooktop. Avoid concentrating weight in specific areas of the cooktop especially near its edges or corners, which will cause stress and strain on the glass.
5. **Weight Limits:** Be cautious when using heavy or oversized cookware. Strictly follow the weight limit specified in this instruction manual.

Understanding these measures and implementing them proactively will ensure the prolong lifespan of your glass cooktop. By following these precautions and this user manual diligently, you'll ensure the enduring your cooktop for years to come.

# Trouble Shooting Tips

Problem	Possible Causes	What to Do
The cooktop cannot be turned on.	No power.	Make sure the cooktop is connected to the power supply and that it is switched on. Check whether there is a power outage in your home or area. If you've checked everything and the problem persists, call a qualified technician.
The touch controls are unresponsive.	The controls are locked.	Unlock the controls. See section 'Using the hob' for instructions.
The touch controls are difficult to operate.	There may be a slight film of water over the controls or you may be using the tip of your finger when touching the controls.	Make sure the touch control area is dry and use the ball of your finger when touching the controls.
The glass is being scratched.	Rough-edge cookware. Unsuitable, abrasive scourer or cleaning products being used.	Use cookware with flat and smooth bases. See 'Choosing the right cookware'. See 'Maintenance and cleaning'.
Some pans make crackling or clicking noises.	This may be caused by the construction of your cookware (layers of different metals vibrating differently).	This is normal for cookware and does not indicate a fault.
The induction hob makes a low humming noise when used on a high heat setting.	This is caused by the technology of induction cooking.	This is normal, but the noise should quieten down or disappear completely when you decrease the heat setting.
Fan noise coming from the induction hob.	A cooling fan built into your induction hob has come on to prevent the electronics from overheating. It may continue to run even after you've turned the induction hob off.	This is normal and needs no action. Do not switch the power to the induction hob off at the wall while the fan is running.
Pans do not become hot and appears in the display.	The induction hob cannot detect the pan because it is not suitable for induction cooking. The induction hob cannot detect the pan because it is too small for the cooking zone or not properly centered on it.	Use cookware suitable for induction cooking. See section 'Choosing the right cookware'. Centre the pan and make sure that its base matches the size of the cooking zone.
The induction hob or a cooking zone has turned itself off unexpectedly, a tone sounds or an error code is displayed.	Technical fault.	Please not down the error letters and numbers, switch the power to the induction hob off at the wall, and contact a qualified technician.

# Failure Display and Inspection

If an abnormality comes up, the induction hob will enter the protective state automatically and display corresponding protective codes:

Fault Code	Possible Cause	Description
E1	Pan or pot fault	No pan or pot, or their size, material, etc. is not suitable, or not placed precisely in the middle of the cooking area.
E2	Voltage is too high	Higher than AC 265V.
E3	Voltage is too low	Lower than AC 185V.
E4	IGBT sensor open-circuit	When the IGBT sensor detects an open-circuit, the IGBT sensor stops working.
E5	IGBT sensor short-circuit	When the IGBT sensor detects a short-circuit, the IGBT sensor stops working.
E6	IGBT sensor over temperature	IGBT reaches $100\pm 5^{\circ}\text{C}$ for 3s(It can recover automatically when temperature decrease $50^{\circ}\text{C}$ - $70^{\circ}\text{C}$ ).
E7	Hob surface sensor open-circuit	After 60 seconds of operation, IGBT stops working when the temperature detection circuit of pot has detected an open-circuit.
E8	Hob surface sensor short-circuit	IGBT stops working when the temperature detection circuit of pot has detected a short-circuit.
E9	High temperature protection of pot sensor	IGBT stops working when the temperature detection circuit of the pot is detected to exceed a certain value.
EA	Pot sensor removal or failure protection	When the pot sensor is moved out, and the whole machine is heated for a period of time, the corresponding area will detect the moving out state of the cooker sensor, and the heating area will stop heating.
EB	Communication fault	The power board does not receive a valid communication signal from the display board for 90 seconds.
EC	Communication fault	The display board does not receive a valid communication signal from the power board for 90 seconds.
H	Hob surface is of high temperature.	After the hob is off, if the hob surface temperature is too high, it will display "H", and the fan will delay working for 2 minutes.

The above are the judgment and inspection of common failures.

Please do not disassemble the unit by yourself to avoid any dangers and damages to the induction hob.

# Technical Specification

<b>Model identification</b>	<b>MBCI625-4FG</b> <b>MBCI625-4FG-F</b>
Cooking Zones	4 Zones
Supply Voltage	220-240V~ 50/60Hz
Installed Electric Power	7200W
Product Size D x W x H (mm)	590×520×60
Building-in Dimensions A x B (mm)	560×490
For circular cooking zones or area: diameter of useful surface area per electric heated cooking zone, rounded to the nearest 5 mm	Bottom Left: 18.0 cm Top Left: 18.0 cm Bottom Right: 18.0 cm Top Right: 18.0 cm

Weight and Dimensions are approximate. Because we continually strive to improve our products, we may change specifications and design without prior notice.

## Environmental Note

Note: Before discarding an old appliance, switch off and disconnect it from the power supply.

Cut off and render any plug useless. Cut the cable off directly behind the appliance to prevent misuse. This should be undertaken by a competent person.



**DISPOSAL:** Do not dispose this product as unsorted municipal waste. Connection of such waste separately for special treatment is necessary.

This appliance is marked according to the European directive 2002/96/EC on Waste electrical and Electronic Equipment (WEEE). By ensuring this product is disposed of correctly, you will help prevent potential negative consequences for the environment and human health, which could otherwise be caused by inappropriate waste handling of this product.

The symbol on the product indicates that it may not be treated as normal household waste. It should be taken to a collection point for the recycling of electrical and electronic goods.

This appliance requires specialist waste disposal. For further information regarding the treatment, recover and recycling of this product please contact your local council, your household waste disposal service, or the shop where you purchased it.

For more detailed information about treatment, recovery and recycling of this product, please contact your local city office, your household waste disposal service or the shop where you purchased the product.

# Warranty

## 1.1 In this warranty:

- 1.1.1 Australian Consumer Law means the law as set out in Schedule 2 of the Competition and Consumer Act 2010;
- 1.1.2 Company means GSM Retail Australia Pty Ltd ABN 53 007 682 475 of 142-144 Fullarton Road, Rose Park SA 5067. Telephone 1300 373 199. Email admin@gsmretailgroup.com
- 1.1.3 Consumer means a "consumer" as that term is defined in Section 3 of the Australian Consumer Law as the original purchaser of a Mistral product;
- 1.1.4 Consumer Guarantees means the guarantees under the Australian Consumer Law;
- 1.1.5 You means the Consumer.

1.2 Nothing in this warranty affects any person's rights under the Australian Consumer Law. The benefits to any consumer under this warranty are in addition to the rights and remedies available under any Consumer Guarantees.

1.3 Subject to the other clauses of this warranty, the Company warrants to the Consumer that the Mistral product will be free of manufacturing defects and will perform to the Company's specifications.

1.4 The benefit of this warranty extends only to the Consumer as original purchaser of a Mistral product which is installed in a domestic household area.  
\*The In Home warranty does not apply to Commercial and or industrial usage.\*Please See 1.7.7 for additional information

1.5 This warranty commences on the date of purchase of the Mistral product by the Consumer and continues for the benefit only of the Consumer until the expiry of !No (2) year (Warranty Period).

1.6 If within the Warranty Period a manufacturing defect is discovered in the Mistral product or it fails to perform to the Company's specifications as a result of some defect in materials, components or workmanship (Defect) then the Company will, at its option, repair the Mistral product or supply a replacement Mistral product free of charge. A replacement Mistral product may differ from the original product purchased by the Consumer.

1.7 This warranty will not apply to any Mistral product:

- 1.7.1 Installed by any person other than a qualified tradesperson; or
- 1.7.2 Subjected to misuse, neglect, negligence or accidental damage; or
- 1.7.3 Operated in any way contrary to any operating or maintenance instructions; or
- 1.7.4 Improperly handled, installed or maintained; or
- 1.7.5 Altered or modified prior to or after installation; or
- 1.7.6 Damaged directly or indirectly by power surges, electrical storm damage or connection to incorrect power supply
- 1.7.7 Industrial and or Commercial usage is inclusive of staff areas in office/ shop environments, hotel motel or other similar accommodation or rental type properties including Bed and Breakfast establishments.

**The Australian Consumer Law requires the inclusion of the following statement with this warranty:**

*Our goods come with guaranteed that cannot be excluded under the Australian Consumer Law. You are entitled to a replacement or refund for a major failure and for compensation for any other reasonably foreseeable loss or damage. You are also entitled to have the goods repaired or replaced if the goods fail to be of acceptable quality and the failure.*

- 1.8 You must provide proof of your purchase of the Mistral product and the date of purchase in order to obtain the benefit of this warranty.
- 1.9 If you live outside the service area of the Company or one of its service agents, this warranty does not cover the cost of transport of the Mistral product for service nor the service agent's traveling costs to and from your home.
- 1.10 If you are required to transport the Mistral product to the Company or its service agent, you must ensure it is safely disconnected by a qualified tradesman and securely packed and insured. The Company does not accept any responsibility for loss or damage of the Mistral product prior to it being received by the Company or its service agent.
- 1.11 You will be responsible for all costs of returning a Mistral product to the Company and for redelivery of the Mistral product by the Company (whether it is the original or a repaired and/or a replacement Mistral product) and for any other expenses you incur in claiming under this warranty.
- 1.12 The Company or its service agent will examine any Mistral product and if the Company determines that it is defective through no fault of the Owner and is otherwise undamaged, the Company will repair or replace the Mistral product in accordance with this warranty.

**DO NOT SEND IN THIS WARRANTY**

Fill out the following details and file with your purchase invoice.

**RETAIN & FILE WITH YOUR RECEIPT**

Your purchase receipt/invoice is proof of date of purchase. If you are unable to establish the date of purchase, or if the fault is not covered by this warranty, or if the product is found to be in working order, you will be required to bear all service call charges.

GSM Retail Australia Pty Ltd reserves the right to discontinue items, modify designs and change specifications without incurring obligation.

Whilst every effort is made to ensure that descriptions, specifications and other information in this publication is correct, no warranty is given in respect thereof and the company shall not be liable for any errors there in. Purchased from:

**Co. Name:**

**Address:**

**Date of Purchase:**

**Serial number:**

**NOTE:** Consistent with our continuing product development policy, improvements may have been made which render the contents of this packaging slightly different to that

**FOR TECHNICAL ENQUIRIES CALL  
1300 373 199 (AUSTRALIA)  
0800 764 912 (NEW ZEALAND)  
TO CONNECT YOU TO THE NEAREST AUTHORISED SERVICE CENTRE**



Gerard Sourcing & Manufacturing

**GSM Retail Australia PTY LTD**

GSM Retail Group has a policy of continual improvement throughout the product range. As such the unit contained within may differ slightly from the unit illustrated on the pack.

MADE IN CHINA for GSM Retail Australia Pty Ltd. Group Companies







