

mīstral

90cm Undermount Rangehood

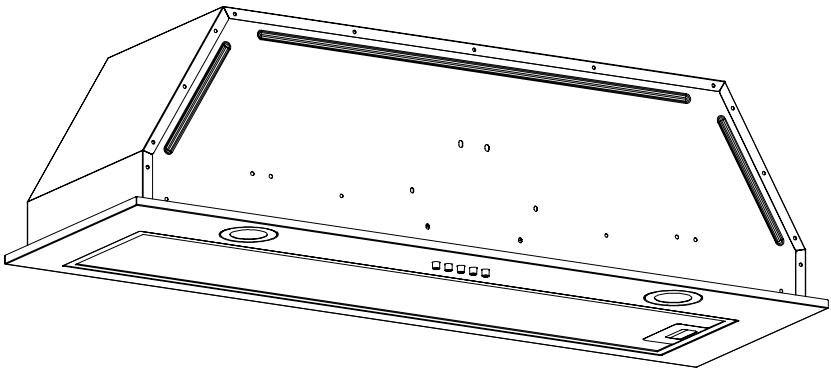

Instruction Manual

Model: MBRU909-7X & MBRU909-7X-F

v1 October 2025

Thank you.

When you step up to a Mistral product, you can rest assured you're making the better choice. Because when you buy a Mistral product you're buying a brand Australian Households have trusted since 1968.

This Mistral appliance carries a 3 year in home warranty, be sure to retain your user manual and receipt.

For all warranty and technical queries please phone:

AUS: 1300 373 199

NZ: 0800 764 912



Contents

Safety Instructions	4
Installation	6
Product Description	6
Product Dimension	6
Using Your Cooker Hood	8
Troubleshooting	8
Maintenance and Cleaning	9
Bulb Replacement	10
Environmental Protection	11

NOTE:

- Reviewing the section on Troubleshooting Tips will help you solve some common problems by yourself.
- If you cannot solve the problems by yourself, please ask for help from a professional technician.
- The manufacturer, following a policy of constant development and updating of the product, may make modifications without giving prior notice.
- If lost or out-of-date, you can receive a new user manual from the manufacturer or responsible vendor.

Safety Instructions

This manual explains the proper installation and use of your cooker hood, please read it carefully before using even if you are familiar with the product. The manual should be kept in a safe place for future reference.

Never do:

- Do not try to use the cooker hood without the grease filters or if the filters are excessively greasy!
- Do not install above a cooker with a high level grill.
- Do not leave frying pans unattended during use because overheated fats or oils might catch fire.
- Never leave naked flames under the cooker hood.



- If the cooker hood is damaged, do not attempt to use.
- Do not flambé under the cooker hood.
- CAUTION: Accessible parts may become hot when used with cooking appliances.
- The minimum distance between the supporting surface for the cooking vessels on the hob and the lowest part of the cooker hood. (When the cooker hood is located above a gas appliance, this distance shall be at least 65 cm)
- The air must not be discharged into a flue that is used for exhausting fumes from appliances burning gas or other fuels. Cooker hoods and other cooking fume extractors may adversely affect the safe operation of appliances burning gas or other fuels (including those in other rooms) due to back flow of combustion gases. These gases can potentially result in carbon monoxide poisoning. After installation of a cooker hood or other cooking fume extractor, the operation of open flued gas appliances should be tested by a competent person to ensure that back flow of combustion gases does not occur.



Always do:

- Important! Always switch off the electricity supply at the mains during installation and maintenance such as light bulb replacement.
- The cooker hood must be installed in accordance with the installation instructions and all measurements followed.
- All installation work must be carried out by a competent person or qualified electrician.
- Please dispose of the packing material carefully. Children are vulnerable to it.
- Pay attention to the sharp edges inside the cooker hood especially during installation and cleaning.
- Make sure the ducting has no bends sharper than 90 degrees as this will reduce the efficiency of the cooker hood.
- Warning: Failure to install the screws or fixing device in accordance with these instructions may result in electrical hazards
- Warning: Before obtaining access to terminals, all supply circuits must be disconnected.
- If the voltage rating of the lamp is less than the rated voltage of the appliance, the voltage rating of the lamp shall also be marked on or near the lamp holder.
- Always put lids on pots and pans when cooking on a gas cooker.
- When in extraction mode, air in the room is being removed by the cooker hood. Please make sure that proper ventilation measures are being observed. The cooker hood removes odours from room but not steam.
- There shall be adequate ventilation of the room when the cooker hood is used at the same time as appliances burning gas or other fuels.
- Cooker hood is for domestic use only.



- If the supply cord is damaged, it must be replaced by the manufacturer, its service agent or similarly qualified persons in order to avoid a hazard.
- This appliance is not intended for use by persons (including children) with reduced physical, sensory or mental capabilities, or lack of experience and knowledge, unless they have been given supervision or instruction concerning use of the appliance by a person responsible for their safety
- Children should be supervised to ensure that they do not play with the appliance.
- This appliance can be used by children aged from 8 years and above and persons with reduced physical, sensory or mental capabilities or lack of experience and knowledge if they have been given supervision or instruction concerning use of the appliance in a safe way and understand the hazards involved. Children shall not play with the appliance. Cleaning and user maintenance shall not be made by children without supervision.
- Caution: The appliance and its accessible parts can become hot during operation. Be careful to avoid touching the heating elements. Children younger than 8 years old should stay away unless they are under permanent supervision.
- There is a fire risk if cleaning is not carried out in accordance with the instructions
- Regulations concerning the discharge of air have to be fulfilled.
- Clean your appliance periodically by following the method given in the chapter MAINTENANCE.

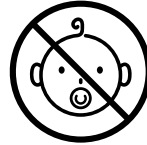

- For safety reason, please use only the same size of fixing or mounting screw which are recommended in this instruction manual.
- Regarding the details about the method and frequency of cleaning, please refer to maintenance and cleaning section in the instruction manual.
- Regarding the information about how the appliance is to be fixed to its support, please refer to Operation section, the Installation procedures in this manual.
- Cleaning and user maintenance shall not be made by children without supervision.



- When the cooker hood and appliances supplied with energy other than electricity are simultaneously in operation, the negative pressure in the room must not exceed 4 Pa (4 x 10⁻⁶ bar).
- **WARNING:** Danger of fire: do not store items on the cooking surfaces.
- A steam cleaner is not to be used.
- **NEVER** try to extinguish a fire with water, but switch off the appliance and then cover flame e.g. with a lid or a fire blanket.

Installation

Product Description

Accessories bag		
Description	Picture	QTY
Blades (150)		2
ST4*18mm screws		8
Installation & User Manual		1

Technical Data

Model	Description	Motor	Airflow	Noise	Others
MBRU909-7X MBRU909-7X-F	90cm Undermount Rangehood	220W	700 m ³ /h 650 m ³ /h (With filter)	48dB rating at fan setting 1	Power Supply:220-240V,50Hz Light: 2x 1.5W LED light Control: 3 speed push button Outlet: 150mm

Product Dimension (mm)

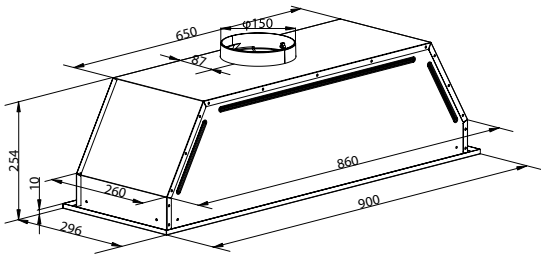

If you have an outlet to the outside, your rangehood can be connected as below picture by means of an extraction duct (enamel, aluminum, flexible pipe or non-flammable material with an interior diameter of 150mm)

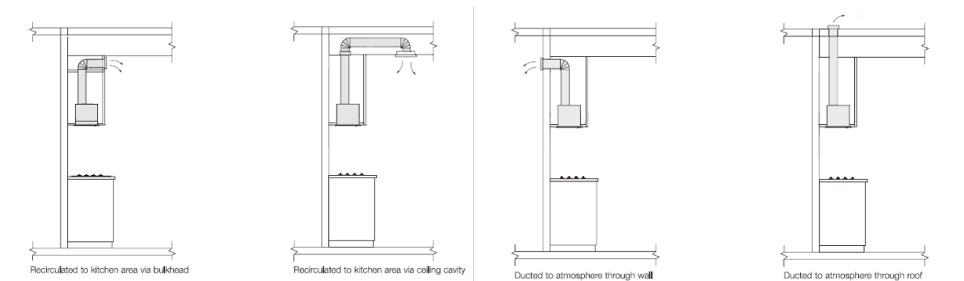

1. Before installation ensure that the cupboard is structurally sound and is capable of carrying the weight of the range hood and that the range hood distance between a cooktop and underneath the range hood must be minimum of 600mm to a cooktop and a maximum height of 750mm.

Where range appliance or range hood is replaced, the overhead clearance from the highest part of the highest burner of the appliance (or hob) to the range hood shall not be less than 600mm unless the appliances manufacturer's instructions specifies a greater clearance.

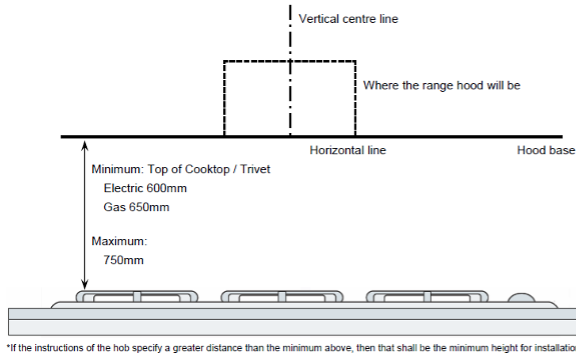

2. Make sure the distance between the edge of the cut out hole and the back of the cupboard is at least 25mm and at least 25mm from the other cut out edges front and sides. The cut out hole in the cabinet should measure Width*depth 865*265 (mm). Refer diagram.
 3. Remove the aluminum filter and remove the two front panel screws.
 4. Use a screwdriver to secure the 8pcs ST4*18 screws and fix the hood body to the cupboard.
 5. Replace the front panel with the two screws and replace the filter.
 6. Install the v-flap to the outlet and fix the expansion pipe to the outlet with a cable tie.
- Note:** The expansion pipe is not included in the product.

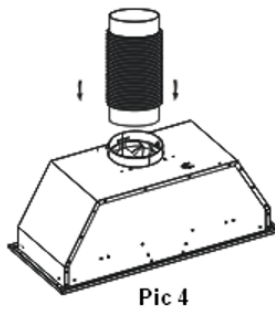
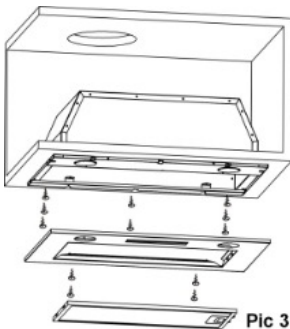
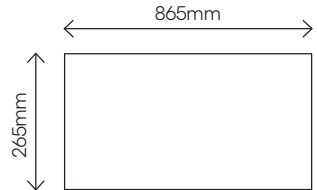

⚠ WARNING

For safety reason, please use only the same size of fixing or mounting screws which are recommended in this instruction manual.

Failure to install the screws or fixing device in accordance with these instructions may result in electrical hazards.

Using Your Cooker Hood

Push buttons

1. Press the **Off** button, and the motor will stop.
2. Press the **Low** button, and the motor will run at low speed.
3. Press the **Middle** button, and the motor will run at mid speed.
4. Press the **High** button, and the motor will run at high speed.
5. Press the **Light** button and the two lights will turn on. Press it again and the light will turn off.

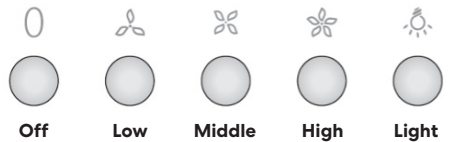

Troubleshooting

Fault	Possible Cause	Solution
Light on, but motor does not work	Fan switch turned off	Select a fan switch position.
	Fan switch failed	Contact service center.
	Motor failed	Contact service center.
Light does not work, motor does not work	House fuses blown	Reset/Replace fuses.
	Mains power cable is loose or disconnected	Refit mains power cable to power outlet. Switch power outlet on.
Oil leakage	One way valve and the outlet are not tightly sealed	Take down the one way valve and seal with sealant.
	Leakage from the connection of chimney and cover	Take chimney down and seal.
Lights not working	Broken or faulty bulbs	Replace bulbs as per these instruction
Insufficient suction	The distance between the cooker hood and the gas top is too far	Refit the cooker hood to the correct distance.
The Cooker hood inclines	The fixing screw is not tight enough	Tighten the hanging screw and make it horizontal.



NOTE:

Any electrical repairs to this appliance must conform to your local, state and federal laws. Please contact the service centre if in any doubt before undertaking any of the above. Always disconnect the unit from the power source when opening the unit.

Maintenance and Cleaning

Caution:

- Before maintenance or cleaning is carried out, the cooker hood should be disconnected from the mains power supply. Ensure that the cooker hood is switched off at the wall socket and the plug removed.
- External surfaces are susceptible to scratches and abrasions, so please follow the cleaning instructions to ensure the best possible result is achieved without damage.

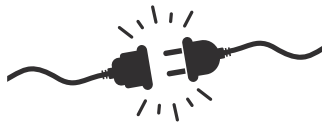

General

Cleaning and maintenance should be carried out with the appliance cold especially when cleaning. Avoid leaving alkaline or acid substances (lemon juice, vinegar etc.) on the surfaces.

Stainless Steel

The stainless steel must be cleaned regularly (e.g. weekly) to ensure a long life expectancy. Dry with a clean soft cloth. A specialized stainless steel cleaning fluid may be used.

NOTE:

Ensure that wiping is done along with the grain of the stainless steel to prevent any unsightly crisscross scratching patterns from appearing.

Control Panel Surface

The inlay control panel can be cleaned using warm soapy water. Ensure the cloth is clean and well wrung before cleaning. Use a dry soft cloth to remove any excess moisture left after cleaning.

Important

Using neutral detergents and avoid using harsh cleaning chemicals, strong household detergents or products containing abrasives, as this will affect the appearance of the appliance and potentially remove any printing of artwork on the control panel and will void manufactures warranty.

Grease Mesh Filters

The mesh filters can be cleaned by hand. Soak them for about 3 minute in water with a grease-loosening detergent then brush it gently with a soft brush. Please do not apply too much pressure, avoid to damage it . (Leave to dry naturally out of direct sun light)

Filters should be washed separately to crockery and kitchen utensils. it is advisable not to use rinse aid.

Following the picture beside to dismantle the grease filter.

Installing Grease Mesh Filters

To install filters follow the following four steps:

- Angle the filter into the slots at the back of the hood.
- Push the button on the handle of the filter.
- Release the handle once the filter fits into a resting position.
- Repeat to install all filters.



Carbon Filter

Activated carbon filter can be used to trap odors. Normally the activated carbon filter should be changed every 3 to 6 months according to your cooking habits. The installation procedure of activated carbon filter is as below:

1. Before installing or replacing the carbon filters, please remove power to the unit.
2. Press the filter lock and remove the mesh filter.
3. Turn the carbon filter on both side of the motor anti clockwise. Replace the carbon filters with the new carbon filters.
4. Place the mesh filter.
5. Connect the power supply to the wall socket.

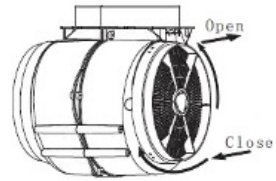

NOTE:

- Make sure the filter is securely locked. Otherwise, it would loosen and cause danger.
- When activated carbon filter attached, the suction power will be lowered.

Bulb Replacement

⚠ IMPORTANT

The bulb must be replaced by the manufacturer, its service agent or similarly qualified persons. Always switch off the electricity supply before carrying out any operations on the appliance. When handling bulb, make sure it has completely cooled down before any direct contact with hands. When handling bulbs hold with a cloth or gloves to ensure perspiration does not come in contact with the bulb as this can reduce the life of the bulb.

Note:

- Before changing the lights, make sure that the appliance is turned off and unplugged.
- Protect against danger when changing lights, such as wearing gloves.

Changing the lights:

1. Remove the grease filter. See step 1.
 2. Detach the two screws on the panel. See step 2.
 3. Disconnect the terminal box and connectors. Using a tool or your fingers, press the spring clips on both sides of the LED light inward until the light is released. Gently pull out the light's connecting wire. See step 3.
- For installation, reverse the above steps.

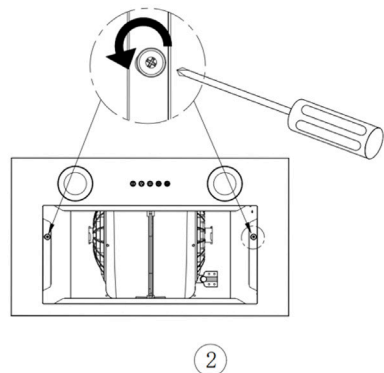
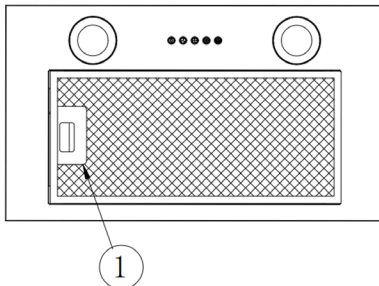

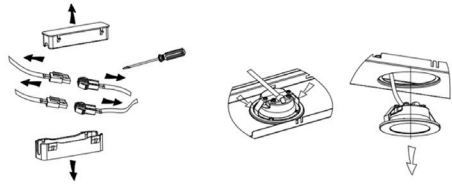
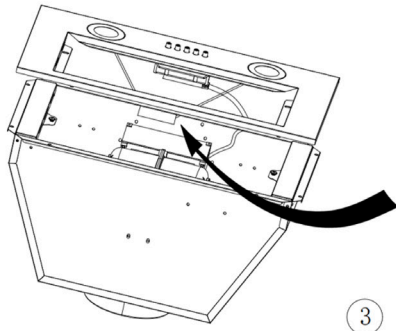

ILCOS D code for this light is: DBR-1.5/65-H-64

- LED modules – round light
- Max wattage: 2x 1.5 W
- Voltage range: AC 220-240V
- Dimensions: (refer diagram)

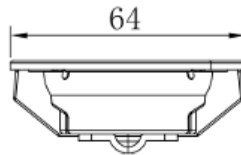

Environmental Protection



This product is marked with the symbol on the selective sorting of waste electronic equipment. This means that this product must not be disposed of with household waste but must be supported by a system of selective collection in accordance with Directive 2012/19/EU. It will then be recycled or dismantled to minimize impacts on the environment, electrical and electronic products are potentially dangerous for the environment and human health due to the presence of hazardous substances. For more information, please contact your local or regional authorities.

NOTE:

The following shows how to reduce total environmental impact (e.g. energy use) of the cooking process .

1. Install the cooker hood in a proper place where there is efficient ventilation.
2. Clean the cooker hood regularly so as not to block the airway.
3. Remember to switch off the cooker hood light after cooking.
4. Remember to switch off the cooker hood after cooking.

Information for Dismantling

Do not dismantle the appliance in a way which is not shown in the user manual. The appliance could not be dismantled by user. At the end of life, the appliance should not be disposed of with household waste. Check with your Local Authority or retainer for recycling advice.

Warranty

1.1 In this warranty:

- 1.1.1 Australian Consumer Law means the law as set out in Schedule 2 of the Competition and Consumer Act 2010;
- 1.1.2 Company means GSM Retail Australia Pty Ltd ABN 53 007 682 475 of 142-144 Fullarton Road, Rose Park SA 5067. Telephone 1300 373 199. Email admin@gsmretailgroup.com
- 1.1.3 Consumer means a "consumer" as that term is defined in Section 3 of the Australian Consumer Law as the original purchaser of a Mistral product;
- 1.1.4 Consumer Guarantees means the guarantees under the Australian Consumer Law;
- 1.1.5 You means the Consumer.

1.2 Nothing in this warranty affects any person's rights under the Australian Consumer Law. The benefits to any consumer under this warranty are in addition to the rights and remedies available under any Consumer Guarantees.

1.3 Subject to the other clauses of this warranty, the Company warrants to the Consumer that the Mistral product will be free of manufacturing defects and will perform to the Company's specifications.

1.4 The benefit of this warranty extends only to the Consumer as original purchaser of a Mistral product which is installed in a domestic household area.

*The In Home warranty does not apply to Commercial and or industrial usage.*Please See 1.7.7 for additional information

1.5 This warranty commences on the date of purchase of the Mistral product by the Consumer and continues for the benefit only of the Consumer until the expiry of three (3) year Warranty Period.

1.6 If within the Warranty Period a manufacturing defect is discovered in the Mistral product or it fails to perform to the Company's specifications as a result of some defect in materials, components or workmanship (Defect) then the Company will, at its option, repair the Mistral product or supply a replacement Mistral product free of charge. A replacement Mistral product may differ from the original product purchased by the Consumer.

1.7 This warranty will not apply to any Mistral product:

- 1.7.1 Installed by any person other than a qualified tradesperson;or
- 1.7.2 Subjected to misuse, neglect, negligence or accidental damage; or
- 1.7.3 Operated in any way contrary to any operating or maintenance instructions;or
- 1.7.4 Improperly handled, installed or maintained;or
- 1.7.5 Altered or modified prior to or after installation; or
- 1.7.6 Damaged directly or indirectly by power surges, electrical storm damage or connection to incorrect power supply
- 1.7.7 Industrial and or Commercial usage is inclusive of staff areas in office/ shop environments, hotel motel or other similar accommodation or rental type properties including Bed and Breakfast establishments.

The Australian Consumer Law requires the inclusion of the following statement with this warranty:

Our goods come with guaranteed that cannot be excluded under the Australian Consumer Law. You are entitled to a replacement or refund for a major failure and for compensation for any other reasonably foreseeable loss or damage. You are also entitled to have the goods repaired or replaced if the goods fail to be of acceptable quality and the failure.

FOR TECHNICAL ENQUIRIES CALL 1300 373 199 (AUSTRALIA) OR 0800 764 912 (NEW ZEALAND)

- 1.8 You must provide proof of your purchase of the Mistral product and the date of purchase in order to obtain the benefit of this warranty.
- 1.9 If you live outside the service area of the Company or one of its service agents, this warranty does not cover the cost of transport of the Mistral product for service nor the service agent's traveling costs to and from your home.
- 1.10 If you are required to transport the Mistral product to the Company or its service agent, you must ensure it is safely disconnected by a qualified tradesman and securely packed and insured. The Company does not accept any responsibility for loss or damage of the Mistral product prior to it being received by the Company or its service agent.
- 1.11 You will be responsible for all costs of returning a Mistral product to the Company and for redelivery of the Mistral product by the Company (whether it is the original or a repaired and/or a replacement Mistral product) and for any other expenses you incur in claiming under this warranty.
- 1.12 The Company or its service agent will examine any Mistral product and if the Company determines that it is defective through no fault of the Owner and is otherwise undamaged, the Company will repair or replace the Mistral product in accordance with this warranty.

DO NOT SEND IN THIS WARRANTY

Fill out the following details and file with your purchase invoice.

RETAIN & FILE WITH YOUR RECEIPT

Your purchase receipt/invoice is proof of date of purchase. If you are unable to establish the date of purchase, or if the fault is not covered by this warranty, or if the product is found to be in working order, you will be required to bear all service call charges.

GSM Retail Australia Pty Ltd reserves the right to discontinue items, modify designs and change specifications without incurring obligation.

Whilst every effort is made to ensure that descriptions, specifications and other information in this publication is correct, no warranty is given in respect thereof and the company shall not be liable for any errors there in. Purchased from:

Co. Name:

Address:

Date of Purchase:

Serial number:

NOTE: Consistent with our continuing product development policy, improvements may have been made which render the contents of this packaging slightly different to that

**FOR TECHNICAL ENQUIRIES CALL
1300 373 199 (AUSTRALIA)
0800 764 912 (NEW ZEALAND)
TO CONNECT YOU TO THE NEAREST AUTHORISED SERVICE CENTRE**



Gerard Sourcing & Manufacturing

GSM Retail Australia PTY LTD

GSM Retail Group has a policy of continual improvement throughout the product range. As such the unit contained within may differ slightly from the unit illustrated on the pack.

MADE IN CHINA for GSM Retail Australia Pty Ltd. Group Companies



